

Paediatrics

- 730 - 738 Bathing
- 739 - 742 Changing
- 743 - 746 Shower & Toileting Chairs
- 747 - 753 Toileting
- 754 - 757 Work Tables
- 758 - 779 Seating
- 779 - 787 Positioning
- 788 - 791 Standing
- 792 - 801 Mobility
- 802 - 808 Pushchairs
- 809 Moving & Handling
- 810 Splinting
- 811 Orthopaedic Supports
- 812 - 821 Sensory Motor
- 822 - 823 Therapeutic Resources
- 824 - 828 Feeding
- 829 Scissors & Craftwork
- 830 - 831 Writing Aids
- 832 Dycem Non-Slip Products





BEST SELLER

1 Bath Corner Chair

Designed to give support to children whilst sitting in the bath. Made from tough ABS plastic and supplied with an adjustableommel and low hook and loop hip strap to aid support and positioning. It is supplied complete with a telescopic safety rail to safeguard children that rock. Suitable for children from 6 months to 12 years. Available in two heights. Both are 390mm wide.

- AA75101S** Height 360mm. Depth 340mm.
- AA75101L** Height 445mm. Depth 330mm.
- AA7510101** Spare Hip Strap
- AA7510102** Spare Bath Hand Rail

Maximum user weight

Small	Large
30 kg	4 1/2 st
35 kg	5 1/2 st



2 Bath Chairs

These specially designed bath chairs enable children to sit in a bath with support. All of these bath chairs are supplied with a pelvic buckle strap, an adjustableommel and two harness straps. The chairs are adjustable in height and are 350mm wide.

- AA75102HB** Small - High Back
Seat depth 250mm. Total length 595mm.
Back height range 490-580mm.
- AA75103HB** Large - High Back
Seat depth 325mm. Total length 715mm.
Back height range 680-640mm.

3 Folding Bath Seat Positioner

A wrap-around style bath seat for children in need of additional trunk support while bathing or playing. The chest harness is height adjustable to grow with the child. It is lightweight and folds flat for easy storage and portability. Made from furniture-grade PVC tubing and vinyl-coated polyester mesh.

Overall width 430mm (17"). Overall length 810mm (32").
Folded: Length 890mm (35"). Seat back height 560mm (22").

554911

Maximum user weight

79 kg	12 1/4 st
--------------	------------------



SPARES
Spares are available for these products, making them suitable for refurbishment. For full spares listing, please see pages 1353 to 1360.

1 Penguin Bath Seat

A lying chair for bathing and play. It provides safe support in a relaxed position but also allows great freedom of movement. Primarily intended for bathing and nursing children but is also suitable for play. Includes an adjustable abduction block and sucking discs, which make the Penguin stable on a smooth surface. The Penguin can be used in the Orca bath tub, as well as being suitable for use in standard baths. Height 260mm. Length 800mm. Width 330mm.

AA75244

AA7524401 Spare Sucker Feet

Maximum user weight



1

2 Orca

This polypropylene bath tub is mounted on adjustable, polyester coated steel frames. When using it, the carer is in the optimal working position when bathing children. The frame is height adjustable and easy to adjust for a carer of almost any height. All of the castors are lockable and it contains a drainage tube, to dispose of used bath water. Suitable for use in conjunction with the Penguin Bath Support.

Specifications

Outer length	1150mm (45")
Inner length	1040mm (40 1/2")
Outer width	600mm (23 1/2")
Inner width	480mm (19")
Height above floor	940-1240mm (36 1/2-48 1/2")

Orca

AA75140

Maximum user weight



ORCA

2



2

THE ORCA CAN BE USED IN CONJUNCTION WITH THE PENGUIN BATH SUPPORT (AA75244)

SDD UK SAME DAY DESPATCH
Delivered from stock. Please contact Customer Services for more information.

DELIVERY
Delivery is approximately 2 to 3 weeks.
Please contact Customer Services for more information.

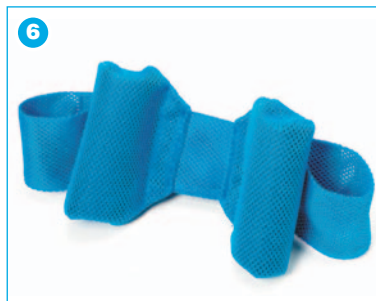

1 Bibi Bath Chair

The Bibi Bath Chair gives children a safe sitting position whilst in the bath. The angle-adjustable backrest allows it to be adjusted to a variety of situations and different positioning needs. The adjustable cover allows shaping of the seat recess to fit the child. The unique design allows it to fold up to a very small size for easy storage, and the lightweight design makes it easy to move and transport. Available in one size with two backrest lengths.

Specifications

Seat Depth	300mm (11 ³ / ₄ "
Seat Width	360mm (14 ¹ / ₄ "
Low Back Height	450mm (17 ³ / ₄ "
High Back Height	550mm (21 ¹ / ₂ "
Total Length	600mm (23 ¹ / ₂ "
Weight	2.3kg.

09 117 8177 Low Back

09 117 8185 High Back

09 117 8193 Chest Strap

09 117 8201 Spare Cover for Low Back

09 117 8219 Spare Cover for High Back

Maximum user weight



2 Bath Support

The Bath Support provides a range of support features for the less involved child. It provides the adjustable positioning angles from 10 to 90° at a fixed height. With back recline and calf plate adjustment, the Bath Support adjusts to a wide range of seating positions. Lightweight and compact, it folds flat for storage and transportation. Rinse clean, breathable, soft fabrics are removable for machine washing. Non-slip pads protect the base of the bath. The frame is made from lightweight stainless steel. Includes Hip Belt and Chest Belt. Head Support 150mm (6"). Back Support 400mm (16"). Seat Height 0-150mm (0-6"). Seat Depth 400mm (16"). Seat Width 430mm (17").

AA75115

Maximum user weight



3 Chest Belt

Not Illustrated

Spare Chest Belt for use with Bath Support. (Supplied as standard).

AA75116

4 Hip Belt

Not Illustrated

Spare Hip Belt for use with Bath Support. (Supplied as standard).

AA75117

5 Abduction Belt

Abduction belt for use with Bath Support.

AA75118S Small

AA75118L Large

6 Head Laterals

Head support for Bath Support.

AA75119

1 Otter Bath Chair

This versatile and supportive bathing system has many adjustable features for positional support in a wide range of seating positions. The durable plastic frame has slip resistant legs and can also be adjusted easily whilst the child is in the chair.

The seat fabric can be slipped off to bathe a child sitting on the floor of the bath tub, supported by the bath chair back. The head cushions are height and width adjustable and provide support and comfort for the child. The head supports can also be used as lateral supports. The seat fabric is machine washable and easy to remove.

Features

- Seat and back are angle adjustable and have five angle adjustments at 0°, 22°, 45°, 67½° and 90°
- Adjustable slip resistant legs raise the chair up to 178mm (7") and can be adjusted with the child in the chair
- Uni-Bars allow the seat and back angle to be adjusted with one hand
- Leg straps control abduction and adduction
- Two positioning straps secure the child
- Head cushions are height and width adjustable and provide support and comfort. They can also be used as lateral supports.
- Folds flat for easy storage

Standard Fabric

09 116 7923 Small

09 116 7931 Medium

09 116 7949 Large



With Soft Fabric

09 142 1114 Small

09 142 1122 Medium

09 142 1130 Large

NEW

NEW

NEW



Accessories

Lateral Supports

09 118 8705

Bath Stand

The Otter Bath stand is suitable for all three sizes and raises the height of the bath chair to a convenient height for easier transfers.

Features

- Slip-resistant legs
- Legs fold flat for storage
- Quick-release locks allow the chair to be attached or removed easily
- Height adjustable from 127 to 254mm (5 to 10")

09 116 7956

Shower Stand

This optional stand brings the child to an ideal height for showering. The stand has lockable castors for manoeuvrability and safety.

09 117 8169

Soft Fabric Kit

Not illustrated

The Soft Otter Bath Chair Fabric has some give for greater comfort. It comes complete with trunk straps and leg straps and has extra padding between the fabric and chair frame.

09 118 8713 Small

09 118 8721 Medium

09 118 8739 Large



BATH STAND

SHOWER STAND

Specifications			
	Small	Medium	Large
Seat Depth	330mm (13")	330mm (13")	419mm (16½")
Seat Width	368mm (14½")	368mm (14½")	368mm (14½")
Back Height	457mm (18")	635mm (25")	813mm (32")
Seat Height	51-178mm (2-7")	51-178mm (2-7")	51-178mm (2-7")
User Height (approx)	Up to 914mm (36")	813-1270mm (32-50")	1168-1727mm (46-68")
Maximum user weight	27 kg / 4¼ st	54 kg / 8½ st	72½ kg / 11¼ st



PICTURED WITH OPTIONAL BASE EXTENSION



ADJUSTS TO 12 POSITIONS



1 Reclining Shower/Bath Chair

A versatile bath and shower chair that fits in all standard baths and showers. Three tilt adjustments of the seat between 30° and 70° allow carers to place the user in a safe and comfortable position. An optional head bolster provides additional support for the head and neck when needed. The optional 230mm (9") base height extension allows carers to raise the chair when needed to accommodate for beds, baths and shower heights and facilitates safer transfers. Adjustable safety belts provide stability once the user is comfortably positioned. Four standard 80mm (3") heavy-duty castors (2 locking) are ideal for roll-in showers, allowing users to be safely transferred outside the shower. This chair has a waterproof PVC frame and an anti-bacterial royal blue mesh fabric seat and seat back. Available in three sizes to accommodate children and adolescents. Seat to floor height 457mm (18").

- 926408** Small Reclining Shower/Bath Chair
- 92640801** Medium Reclining Shower/Bath Chair
- 92640802** Large Reclining Shower/Bath Chair

Accessories

- 92640803** Optional 230mm(9") Height Extension - fits all Models
- 92640804** Optional Head Bolster - Small
- 92640805** Optional Head Bolster - Medium
- 92640806** Optional Head Bolster - Large

Reclining Shower/Bath Chair Specifications

	Small	Medium	Large
Interior Width:	340mm	340mm	380mm
External Width:	430mm	430mm	500mm
Seat Depth:	460mm	510mm	460mm
Back Length:	580mm	640mm	790mm
Total Length:	1040mm	1140mm	1240mm
Total Height:	500mm	500mm	740mm
Max User Height:	1020mm	1020-1370mm	1370-1780mm
Max User Weight:	45kg (7st)	59kg (9 ¹ / ₄ st)	82kg (12 ³ / ₄ st)

2 Articulating Shower/Bath Chair

This bath chair has a seat and back that can independently articulate with ease, even with the user in the chair. The seat has full head and trunk support. The strong mesh vinyl sling drains well and removes easily for washing. Available in three sizes. The optional base extension raises the user 230mm (9") from the floor for easier use. All chairs come with non-slip rubber feet and fold flat for storage. Colours may vary from those pictured.

- 557389** Small Shower/Bath Chair
- 557390** Medium Shower/Bath Chair
- 557391** Large Shower/Bath Chair
- 557392** 230mm (9") Base Extension
- 557393** 230mm (9") Base Extension with Castors

Articulating Shower/Bath Chair Specifications

	Small	Medium	Large
Internal Length:	737mm	914mm	1194mm
External Length:	813mm	991mm	1270mm
Back Height:	483mm	635mm	813mm
Seat Depth:	330mm	356mm	457mm
Internal Width:	356mm	356mm	356mm
External Width:	432mm	432mm	432mm
Total Height:	102mm	102mm	102mm
Max User Weight:	45kg (7st)	59kg (9 ¹ / ₄ st)	82kg (12 ³ / ₄ st)

INFORMATION
For our range of paediatric shower commode chairs, please see pages 743 to 746.



1 Tumble Forms Starfish Bath Chair

Sammons Preston

Makes bath time more enjoyable for caregiver and child.

The Starfish Bath Chair is designed for simple functionality and adjustability. Height adjustable chair legs with angle adjustable back and leg supports offer a range of height and angle positions so the child and caregiver are more comfortable. Only one hand is needed to release the leg and seat locks located on both sides of the chair making bath time adjustments quick and simple. The padded support bars give added positioning comfort. The aluminium frame is easy to lift and carry, and the chair folds flat for convenient storage or transportation. Non-slip foam pads provide secure bath placement for stability and security. The seat features extra soft, breathable mesh material that is removable for machine washing and is available in a choice of four colours. An adjustable Hip Belt and Chest Belt are included to provide secure positioning and optional abduction straps and head laterals are available as accessories. Available in four sizes to accommodate the youngest child through to adolescence.

Star Fish Bath Chair				
	X-Small	Small	Medium	Large
Ocean Blue	09 142 5313	09 142 5370	09 142 5446	09 142 5487
Red	09 142 5339	09 142 5404	09 142 5453	09 142 5495
Purple	09 142 5347	09 142 5420	09 142 5461	09 142 5503
Pink	09 142 5354	09 142 5438	09 142 5479	09 142 5511

Accessories Abduction Strap

	X-Small & Small	Medium & Large
Ocean Blue	09 142 5529	09 142 5560
Red	09 142 5537	09 142 5578
Purple	09 142 5545	09 142 5586
Pink	09 142 5552	09 142 5594

Head Laterals

	One Size Fits All
Ocean Blue	09 142 5602
Red	09 142 5610
Purple	09 142 5628
Pink	09 142 5636

Maximum user weight **72 kg** **11 1/4 st**

2 Shower Base for Starfish Bath Chair

Sammons Preston

This optional shower base easily attaches to the Starfish Bath Chair to provide a strong, stable, manoeuvrable base allowing easy transport. The base brings the child to the ideal height so that the bath chair can also be used as an adjustable shower chair. The trolley has four lockable castors to safety and security. Floor to base height 356mm (14"). Width 533mm (21"). Length: 864 to 1219mm (34" to 48"). Seat height from floor 508 to 711mm (20" to 28").

09 142 5768

Star Fish Bath Chair Specifications					
Size (mm)		X-Small	Small	Medium	Large
User Height	Minimum	800mm (31 1/2")	900mm (35")	1100mm (43")	1300mm (51")
	Maximum	1000mm (39")	1200mm (47")	1400mm (55")	1650mm (65")
Head Support		150 mm (6")	150 mm (6")	215mm (8 1/2")	215 mm (8 1/2")
Back Support Height		350mm (14")	400 mm (16")	460 mm (18")	550 mm (22")
Seat Depth		225 mm (9")	275 mm (11")	335 mm (13")	400 mm (16")
Seat Width		400 mm (16")	400 mm (16")	400 mm (16")	400 mm (16")
Leg Support		260 mm (10")	260 mm (10")	340 mm (13")	340 mm (13")
Overall Length		975 mm (39")	1050mm (42")	1313mm (52 1/2")	1488mm (59 1/2")
Seat Height		50-425mm (2-17")	50-425mm (2-17")	50-425mm (2-17")	50-425mm (2-17")





1 Dolphin Bath Chair

The Dolphin Bath Chair benefits from a seat and back angle that can adjust independently. It includes two adjustable positioning belts and a headrest for safety, comfort and support. The back support has 10 angle positions including trendelberg and the seat has 5 tilt positions as well as being adjustable in depth. The aluminium frame is covered in a quick-drying sea green mesh fabric. Folds for easy storage and an optional base is available to raise the height of the bath chair.

Specifications

Length	1000 -1130mm (39 1/2-44 1/2")
Seat Depth	330-457mm (13-18")
Height from Floor	152mm (6")
Back Height	610mm (24")
Width	432mm (17")
Weight	2.7kg
Base adds Height	279-457mm (11-18")

09 132 9465 Dolphin Bath Chair

09 132 9473 Adjustable Base

Maximum user weight **45 kg** **7 st**



2 Sub Bath Support

The Sub is a supportive seating system for children, to be used in the bath and around the home. It has been designed to assist in the bathing of children and is particularly suitable for children with limited upper body stability. The backrest is adjustable with three incline settings and the option to lay flat in the bath. The thin cross section of the base board means that the lowest part of the baseboard is only 5mm above the bottom of the bath allowing for shallow water bathing.

Specifications

Overall length	1130mm
Overall width	370mm
Max. height	750mm
Max. user height	1350mm (4'5")
Angle of backrest adjustment	Flat to 70°
Weight	3.2kg (7lbs)

AA75245

Maximum user weight **50 kg** **7 3/4 st**

Adjustable Pommel

Not illustrated

A pommel with a hook and loop base that can easily be positioned to suit the child.

AA75243



3 Child's Bath Support

Adjustable bath supports give children the freedom to play while seated upright in a bath, on the floor or wherever a stable support is desired. The base on all three is 710mm long and 430mm wide, and has excellent stability. High impact, ABS plastic back, PVC frame and stainless steel fittings.

- 6224** Small, height adjusts from 230-360mm (9-14"), Back Support is 220mm (8 1/2") wide
- 622401** Medium, height adjusts from 250-360mm (10-14"), Back Support is 300mm (12") wide
- 622402** Hi-Back, height adjusts from 480-600mm (19-23 1/2"), Back Support is 360mm (14") wide

For added comfort there are seamless, waterproof padded support cushions available. These soft cushions are moulded for a perfect fit. They attach securely with hook and loop and wipe clean easily. Latex free.

- 637005** Padded Cushion for 6224
- 637001** Padded Cushion for 622401
- 637003** Padded Cushion for 622402

1 Advance Bath Chair

Designed with functionality and ease of adjustability in mind, the Advance Bath Chair has a great range of positional support elements. Available in four sizes and with the option of a shower trolley conversion, it suits the youngest child though to adolescents. Simple levers allow an extensive range of seating positions and the chair folds flat for storage and transportation. The lightweight frame is made from durable stainless steel. The chair comes complete with a hip and a chest belt. Abduction strap and head laterals supports are available as optional accessories.

The breathable, soft fabrics are rinse clean and removable for machine washing. Non-slip pads protect the base of the bath. Seat height 50 to 425mm (2 to 17"). All chairs 445mm (17 1/2") wide.

X-Small

AA75113XS	Head Support	150mm
	Back Support	350mm
	Seat Depth	225mm
	Calf Support	260mm

Small

AA75113S	Head Support	150mm
	Back Support	400mm
	Seat Depth	275mm
	Calf Support	260mm

Medium

AA75113M	Head Support	215mm
	Back Support	460mm
	Seat Depth	335mm
	Calf Support	340mm

Large

AA75113L	Head Support	215mm
	Back Support	550mm
	Seat Depth	400mm
	Calf Support	340mm

Maximum user weight



2 Chest Belt

Not Illustrated

Spare Chest Belt for use with Advance Bath Seat. (Comes as standard).

AA75116

3 Hip Belt

Not Illustrated

Spare Hip Belt for use with Advance Bath Seat. (Comes as standard).

AA75117

4 Abduction Belt

Available in two sizes, small for extra small and small Advance Bath Chair, and large for medium and large Advance Bath Chair.

AA75118S Small

AA75118L Large

5 Head Laterals

Head support for Advance Bath Seat. Fits all sizes of Advance Bath Seat.

AA75119

6 Shower Trolley

The Advance Bath Chair is even more versatile with the shower trolley conversion. Converting in seconds, it brings the child to the ideal height within a strong, stable base. Swivel castors ensure the trolley can be easily manoeuvred in shower cubicles. Seat height from floor 650 to 700mm (26 to 28"). Length 900 to 1150mm (36 to 45"). Width 600mm (24").

AA75114

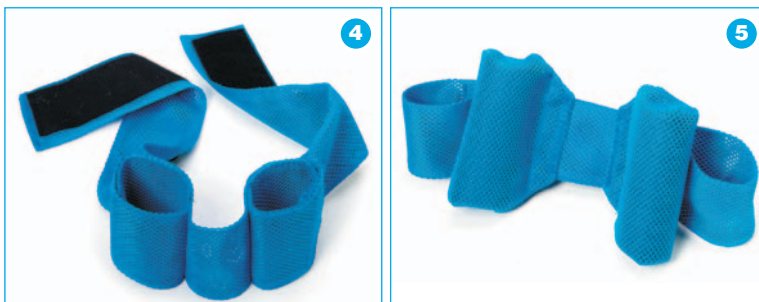

SPARES
Spares are available for these products, making them suitable for refurbishment. For full spares listing, please see pages 1353 to 1360.



Surfer Bather Child's Bath Lift

The Surfer Bather is a powered bath lift that is designed to aid the bathing of children. It is particularly suitable for children with limited upper body stability. The child is raised and lowered from the top level of a bath down into the water. This minimises moving and handling risks among carers of larger and heavier children. The Surfer Bather is operated by low air pressure providing a steady, gentle and stable ride. An adjustable backrest can be set to suit the user. The child can be positioned safely and comfortably by using protective strapping and an optional pommel. The bath lift can be dismantled into separate sections for easy storage and transportation. The Surfer Bather fits most standard baths. It can be operated by using the corded remote control, or by the controls on the Airflo battery compressor.

Specifications

Overall length	1170mm (46")
Overall width	410mm (16") min 685mm (27") max
Max user height	1350mm (4' 5")
Angle of backrest adjustment	Flat to 70°
Platform height	55-430mm (2-17")
Platform weight	4.2kg (9lbs)
Scissor lift weight	4.5kg (10lbs)
Max air pressure	0.35 bar (epi)

Maximum user weight



1 Surfer Bather Child's Bath Lift with Airflo Battery

Includes bathing platform with backrest, soft headrest, body belt, side restraining clips, elevating scissors with bellows, Airflo battery and remote control unit.

AA75241

2 Surfer Bather Child's Bath Lift with Airflo Battery Compressor, Leg Straps and Side Rails

Includes bathing platform with backrest and side rails, soft headrest, body belt, leg straps, side retaining clips, elevating scissors with bellows, Airflo battery and remote control unit.

AA75242

3 Adjustable Pommel

A pommel with a hook and loop base that can be easily positioned to suit the child.

AA75243



1 Changing Table

Constructed of steel tubing and covered with woven polyester, this table is both durable and hygienic. The covering resists stains and is easily cleaned using common household cleaners. The table can be attached to a wall and folded out of the way when not in use. When in use, the legs lock securely in place. Can also serve as a shower stretcher.

Available in two lengths, 1900mm (74³/₄") and 1500mm (59"). 700mm (27¹/₂") wide, 900mm (35¹/₂") high (both models).

4521	Large	1900mm	Standard
452101	Small	1500mm	Standard

Maximum user weight



Side Rail

Rail installs onto changing table by clamps included. No tools required. Length 1245mm (49") x Height 203mm (8").

924521

2 Paediatric Changing Table

Homecraft

The paediatric table can be fitted with cot sides for patient safety and has excellent manoeuvrability due to retractable wheels. It is also brightly coloured making it more fun for children and aiding compliance. It is strong and robust and has a two-year guarantee.

- Hand switch control on electric model
- Retractable wheels
- 160mm clearance for mobile hoist
- Length 1500mm. Width 700mm. Height adjustable from 500 to 920mm.

AA95111	Electric UK Plug
09 115 8096	Hydraulic
09 115 8104	Electric EU Plug

Maximum user weight



3 Paediatric Two Column Changing Table

Homecraft

This height adjustable changing table is designed to assist with the moving and handling of children and adults while they are being changed. It has a height range of 520-1030mm (+100mm for Mobile versions with castors) to provide safe transfer heights and a safe working height. The height adjustment is easily controlled using a simple battery powered rechargeable hand controller. It is available as either a 1200mm or 1500mm length and with or without castors. It is brightly coloured to aid compliance and the strong and robust design ensures a long life with minimal maintenance.

Two year guarantee.

- Rechargeable Hand Controller
- Manufactured with anti-bacterial coating
- Width 700mm. Two Length options. Height adjustable from 520 to 1030mm on standard versions and 620 to 1130mm on mobile versions.

Standard without Castors

09 118 2781	Length 1200mm
09 118 6923	Length 1500mm

Mobile with Castors

09 120 6085	Length 1200mm
09 120 6093	Length 1500mm

Maximum user weight



MADE TO ORDER
This item is made to order and, therefore, is not refundable.

NDD UK NEXT DAY DESPATCH
Delivered from stock. Please contact Customer Services for more information.

INFORMATION
We recommend that all benches and tables are installed by a qualified tradesman.



1 Pressalit Nursing Bench 150

This height adjustable nursing bench helps with the safe moving and handling of children and adults when they are being changed or showered. The bench moves from wheelchair level (500mm) to a safe working height (900mm) (note these heights are dependent on fixing position). This movement is easily controlled by a simple, remote control hand unit. It folds upright when not in use to save space.

The bench has a nylon coated steel frame and practical and durable PVC canvas. A splash protection curtain is available as an accessory to protect the carer from water splashes as it passes through the drainage holes on the bench. A safety rail is also supplied as standard. Available in two lengths.

Width of bench 600mm (23¹/₂"). Total width (edge of bench to wall when fitted) 735mm (30"). Width of lifting unit 750mm (29¹/₂"). Depth of lifting unit 115mm (4¹/₂").

09 132 8020 Length 1400mm

09 142 2575 Length 1800mm

Maximum user weight



2 Pressalit Free Standing Nursing Table

This height adjustable nursing table enables carers, for example in a day nursery or daycare centre, to find the right working position and avoid having to lift children unnecessarily when attending to their needs. It is freestanding and is adjustable in height via an electric motor, with remote control. Height adjustable from 650 mm - 1000 mm. The tables all includes two wire baskets for storage and are available in versions with sanitary appliances including stainless steel sink, tap, showerhead and feed/waste system.

	Length
09 142 4118 Standard	900mm
09 142 4126 Standard	1400mm
09 142 4134 With Sanitary Appliances	1400mm

Maximum user weight



09 142 4142 Standard	1800mm
09 142 4159 With Sanitary Appliances	1800mm

Maximum user weight





1 Pressalit Nursing/Shower Bench

This height adjustable nursing bench is designed to help with the safe moving and handling of children and adults while they are being changed or showered. The bench is slightly curved making it extremely comfortable and safe. The height adjustable bench can be adjusted from a suitable transfer height (300mm) to a safe caring height (1000mm) (note these heights are dependent upon fixing position). This movement is easily controlled by a simple, remote control hand unit. When the fixed height bench is mounted at the recommended height, the lying surface height is 865mm above the floor. The integrated gas cylinder also enables the bench to be folded easily against the wall when not in use to maximise floor space.

The nursing bench benefits from a water collection tray with an integrated water outlet that prevents water from splashing on carers or on the floor. The bench, end caps and safety rail are all covered with polyurethane foam so that there are no cold surfaces exposed. The bench also benefits from a manually adjustable back support at both ends for increased comfort for the user. The safety rail can be easily folded up or down using only one hand. Available in two adjustable height versions and two fixed height versions.

Supplied complete with safety rail Adjustable Height Bench

09 117 4721 Total Length 1430mm

09 117 4739 Total Length 1930mm

Fixed Height Bench

09 117 4747 Total Length 1430mm

09 117 4754 Total Length 1930mm

Spares

09 117 4762 Safety Rail 1636mm

09 117 4770 Safety Rail 1200mm

Maximum user weight



FOLDED AWAY

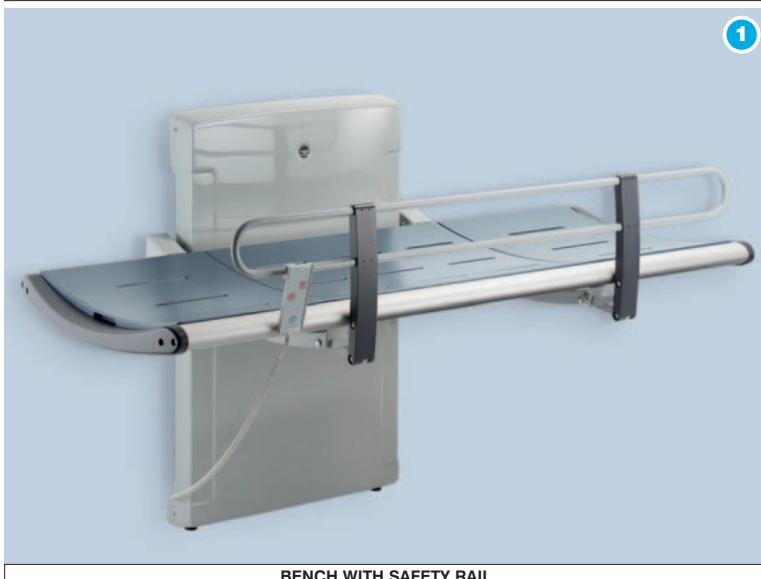

BENCH WITH SAFETY RAIL

SPARES
Spares are available for these products, making them suitable for refurbishment. For full spares listing, please see pages 1353 to 1360.

DELIVERY
Delivery is approximately 4 weeks. Please contact Customer Services for more information.



1 SKM Freestanding Easychange™ Changing Table

This extremely versatile platform has a staggering height range from 35 to 108cm and can carry a load of up to 100kg. Its attractive non-clinical design ensures it never looks out of place, wherever it is used. Safety is paramount and padded safety rails at the side and a steel back panel ensure containment on all sides when the operator is in front of the table. Mains powered with remote control and folds to easily save space when not in use. The legs are not folding. Total distance from wall when folded 52cm (20"). Length 120cm (47"). Width 70cm (27"). Height adjustment 35 - 108cm (13 - 42"). Note: Not intended for use in wet areas.

AA95091 Folding

Maximum user weight **100 kg** **15³/₄ st**



2 Shower Trolley

This range of shower trolleys is designed to allow washing or showering of patients in a supine position. Mobile and easy to manoeuvre, it makes transferring a patient to the bathing area simple, allowing the patient to be showered, dried and clothed whilst minimising the risk of back injury to the carer. Three locking castors prevent movement during patient transfer and the fourth castor has directional locking to assist manoeuvrability. The height adjustable models can be adjusted from either side, setting the trolley at a convenient height and avoiding the need for stretching or leaning. Drop down sides on both sides of the trolley enable transfer of the patient, whilst the padded liner and head support improve comfort.

Surface area 1930 x 750mm (76 x 29¹/₂"). Depth of sides 200mm (8"). Height of fixed model 960mm (37³/₄"). Height of adjustable models 580 to 960mm (23 to 37³/₄").

AA1760 Fixed Height

AA1761 Hydraulic Height Adjustment

AA1762 Electric Height Adjustment UK Plug

09 117 1024 Electric Height Adjustment EU Plug

09 117 1032 Electric Height Adjustment AUS Plug

Maximum user weight **190 kg** **30 st**



3 Changing/Shower Stretcher

A Changing/Shower Stretcher that is safe, sturdy and convenient. It is fixed to the wall and has two fold-down legs that provide extra support. The whole frame can be folded up against the wall to save space. The tough PVC cover has holes to allow water to drain away easily. Available with an integral back support option that can be adjusted to 7 positions, allowing the user to sit up if required (shown).

Stretcher width 750mm (29¹/₂"). Stretcher length 1900mm (75"). Leg length 900mm (35¹/₂"). Projection from wall (unfolded) 875mm (34¹/₂"). Projection from wall (folded) 110mm (4¹/₂").

AA75111 Shower/Changing Stretcher

AA75112 Shower/Changing Stretcher (Adj. Back)

Maximum user weight **180 kg** **28 st**



MADE TO ORDER
This item is made to order and, therefore, is not refundable.

DELIVERY
Delivery is approximately 3 to 6 weeks. Please contact Customer Services for more information.

1 Seahorse Sanichair

The design of the Seahorse Sanichair is based around two sizes of frame each accommodating two sizes of liners to provide four size options. This allows the liner to be replaced with the next size as the child grows. The frame allows the Seahorse to fit over the majority of toilets within the domestic or school setting whilst the high centre of gravity enables the child to be tilted for washing and showering.

Features

- Positive locking on the headrest, footrest and potty, adding extra security for the child and carer
- Contoured splashguard suitable for use by a wide range of children
- Plastic and aluminium construction for durability eliminates rusting and aids ease of cleaning
- Simple tilting mechanism to facilitate showering in a variety of positions
- Height adjustable headrest, footrest and frame to suit a variety of patients and settings
- Soft foam liners for comfort and hygiene
- Elongated aperture for easier personal cleaning
- Contoured seat to provide support and facilitate toileting
- Large braked castors for ease of movement
- Detachable splash guard aids abduction and may be removed for easier access
- Large capacity detachable potty is easy to remove and clean
- Soft foam headrest for comfort and support

Includes contoured seat, water and chip resistant metal frame, large castors, removable splash guard pommel, large capacity potty, adjustable footplate, body harness and foot straps.

Specification

Maximum user weight



Unit Weight: Small 15kg, Large 17kg.

SEAHORSE SANICHAIR - SMALL

AA75251 For 3-9 years

MINI LINER - SIZE 1

AA75253 For 3-6 years

MIDI LINER - SIZE 2

AA75254 For 5-9 years

SEAHORSE SANICHAIR - LARGE

AA75252 For 9-16 years

MAXI LINER - SIZE 3

AA75255 For 9-12 years

SUPER MAXI LINER - SIZE 4

AA75256 For 12-16 years

HEADREST

Height and depth adjustable. Soft foam headrest for use with large and small Seahorse.

AA75257



SPARES

Spares are available for these products, making them suitable for refurbishment. For full spares listing, please see pages 1353 to 1360.



Dimensions

	Small			Large		
	Mini Liner	Midi Liner	Without Liner	Maxi Liner	Super Maxi	Without Liner
Seat Depth	300mm	345mm	360mm	410mm	435mm	440mm
Rear Width of Seat	250mm	290mm	310mm	335mm	370mm	390mm
Front width of Seat	290mm	340mm	370mm	380mm	420mm	450mm
Height of Back	430mm	430mm	450mm	540mm	540mm	560mm
Total Width	540mm	540mm	540mm	630mm	630mm	630mm
Min. Height of Seat	520mm	520mm	520mm	520mm	520mm	520mm
Max. Height of Seat	625mm	625mm	625mm	625mm	625mm	625mm

1



SWAN COMMODE PICTURED WITH SEAT COVER, H BELT AND HEADREST (SOLD SEPARATELY)

1 Swan Commode

The Swan Commode is an all purpose hygiene chair designed for children and small adults. It can be used in the shower, over most toilets or as a commode. It is available in a range of sizes to suit the needs of most users. The seat reclines 45° from +15° to -30° and the legs are height adjustable. The seat is made from fibreglass and the frame from powder coated stainless steel.

An adjustable footrest is included and all four castors have brakes. Also includes Commode pan.

- AA75212S Small
- AA75212M Medium
- AA75212L Large
- AA75212XL X-Large
- AA75212XXL Small Adult

A range of accessories and spares are available. These include

- AA75213S Padded Seat Cover - Small
- AA75213M Padded Seat Cover - Medium
- AA75213L Padded Seat Cover - Large
- AA75213XL Padded Seat Cover - X-Large
- AA75213XXL Padded Seat Cover - Small Adult
- AA75215 Footstraps for Footrest
- AA75214 Short Foot Support Bar (350mm)
- AA7525008S Net Cross Vest - Small
- AA7525008L Net Cross Vest - Large
- AA7525008XL Net Cross Vest - X-Large
- AA75216XS H Belt - X-Small
- AA75216S H Belt - Small
- AA75216M H Belt - Medium
- AA75216L H Belt - Large
- AA75216XL H Belt - X-Large
- AA75217S Tray - Small
- AA75217M Tray - Medium
- AA75217L Tray - Large
- AA75217XL Tray - X-Large
- AA75217XXL Tray - XX-Large
- AA7525009 Headrest



Swan Commode - Specifications					
	AA75212S	AA75212M	AA75212L	AA75212XL	AA75212XXL
Seat Depth	270mm	325mm	380mm	460mm	460mm
Seat Width (back)	200mm	250mm	300mm	340mm	410mm
Seat Width (front)	300mm	360mm	380mm	430mm	480mm
Back Height	380mm	400mm	480mm	570mm	570mm
Total Width	495mm	535mm	535mm	575mm	655mm
Seat Height	280-440mm	390-550mm	390-550mm	390-550mm	390-550mm
Seat Height + Wheels	+100mm	+100mm	+100mm	+100mm	+100mm
Max User Weight	30kg	70kg	80kg	90kg	110kg

SPARES
Spares are available for these products, making them suitable for refurbishment. For full spares listing, please see pages 1353 to 1360.

DELIVERY
Delivery is approximately 2 to 3 weeks. Please contact Customer Services for more information.

1 Flamingo Chair

The Flamingo offers great versatility in the bathroom. Designed with several different seating options, it can be positioned over a toilet, tilted over a sink or bath or wheeled into a shower. Using the optional suction cups, the removable seat can be securely placed in the bath for bathing. Includes seat, splashguard, footrest and mobile frame.

Features

- Both seat and back adjust individually to allow for comfortable positioning
- The frame is height adjustable 500 to 600mm floor to seat
- Footrest is height and angle adjustable
- Four lockable castors
- 100% waterproof upholstery
- Aluminium frame folds for easy transportation and storage
- Removable plastic seat

- AA75250S** Small
AA75250L Large
AA75250XL X-Large

Specifications

	Small	Large	X-Large
Seat width	280mm	320mm	340mm
Shoulder width	320mm	380mm	400mm
Seat depth	320mm	360mm	420mm
Back width	320mm	380mm	400mm
Back height	400mm	430mm	470mm
Seat to footrest length	250-350mm	300-400mm	290-430mm
Seat height to floor	500-600mm	500-600mm	500-600mm
Frame width	460mm	500mm	540mm
Frame and seat height	890mm	930mm	950mm
Frame base length	660mm	660mm	660mm
Weight of seat	13kg	14kg	15kg
Maximum User Weight	50kg (7 ¹ / ₂ st)	60kg (9 ¹ / ₂ st)	70kg (11st)

Accessories

- AA7525001** Swingaway Side Supports - Fits Both
AA7525002S Swingaway Armrest and Tray - Small
AA7525002L Swingaway Armrest and Tray - Large
AA7525002XL Swingaway Armrest and Tray - X-Large
AA7525003S Commode Pan with Holder - Small
AA7525003L Commode Pan with Holder - Large
AA7525003XL Commode Pan with Holder - X-Large
AA7525004S Spare Commode Pan - Small
AA7525004L Spare Commode Pan - Large
AA7525004XL Spare Commode Pan - X-Large
AA7525005S Sides for Back with Upholstery - Small
AA7525005L Sides for Back with Upholstery - Large
AA7525005XL Sides for Back with Upholstery - X-Large
AA7525006 Suction Caps for Bath Use
 Fits Small/Large
AA7525007S Hardware for Toilet Mounting - Small
AA7525007L Hardware for Toilet Mounting - Large
AA7525007XL Hardware for Toilet Mounting - X-Large
AA7525008S Net Cross Vest - Small
AA7525008L Net Cross Vest - Large
AA7525008XL Net Cross Vest - X-Large
AA7525009 Headrest
09 115 7718 Ankle Strap - Small
09 115 7726 Ankle Strap - Large
09 115 7734 Ankle Strap - X-Large



FLAMINGO SEAT SHOWN WITH SIDE EXTENDERS, SWINGAWAY ARMREST AND TRAY, COMMODE PAN WITH HOLDER AND HEADREST



DELIVERY
 Delivery is approximately 2 to 3 weeks. Please contact Customer Services for more information.



1 Wheeled Shower Commode Chair

This comfortable chair will suit children who do not require high levels of postural support. It features armrests and footrests that swing away for easy side transfer and is brightly coloured to appeal to children. The padded seat has a removable centre allowing it to be used in the shower, over the toilet or as a commode using the pan supplied. The chair is highly durable and has an upholstered seat making it easy to clean and kind to the skin. It has four castors - the two rear castors are swivelling and braked to allow easy directional control and transfer.

Specifications

Overall Depth	540mm (21 ¹ / ₄ "
External Width	530mm (20 ³ / ₄ "
Seat Depth	340mm (13 ¹ / ₄ "
Seat Height	545mm (21 ¹ / ₂ "
Seat Width	400mm (15 ³ / ₄ "
Max. Toilet Height	430mm (17")
Max. Toilet Height Without Commode Pan	470mm (18 ¹ / ₂ "
Weight	16.9kg

AA75260

Maximum user weight



Accessories

AA75261	Height Adjustable Headrest
AA75262	Spare Commode Pan
AA75263	Safety Belt



2 Shower Commode Seat Adjustment

This adjustment accessory allows the seat width and depth on the Shower Commode Chair above (AA75260) to be adjusted. The attachment has adjustable armrests, a backrest adjustment and a height adjustable foot support. This allows the shower commode chair to accommodate smaller children and adjust to suit the child as they grow.

Specifications

Minimum Seat Depth	250mm (9 ¹ / ₄ "
Minimum Seat Width	225mm (8 ³ / ₄ "
Maximum Seat Depth	295mm (11 ¹ / ₂ "
Maximum Seat Width	325mm (12 ³ / ₄ "
Weight	3.5kg

AA75264



3 PVC Shower Commode Chair

This three-in-one chair can be used as a commode, shower chair or as a safety frame over a junior toilet. The PVC frame permits safe client transfer and the safety-belt features side release buckles for quick removal. Snaps keep the belt with the chair when not in use. The removable back is made of durable vinyl coated polyester mesh. The commode pan can be removed when the patient is seated. The detachable footrest enhances comfort and the hinged seat allows easy cleaning. Four deluxe 76mm (3") locking zinc castors hold the chair in place. Height 940mm (37"). Width 470mm (18¹/₂"). Depth 553mm (21"). Floor to top of seat 457mm (18"). Weight 8.6kg.

6548

Maximum user weight



SPARES
Spares are available for these products, making them suitable for refurbishment. For full spares listing, please see pages 1353 to 1360.

**1 Tumble Forms 2™
Carrie™ Potty Seat**

Sammons
Preston

This potty seat is specially designed to meet the toileting needs of users with heights ranging from 1250mm (48 to 68") and weighing up to 59kg (9 1/4st). The seat is shaped to position legs in flexion and abduction to encourage bladder and bowel functions. It can be positioned over toilets or used as a free standing commode, so it's ideal for clinical, school or home use.

Features

- Lateral supports and tray to help provide trunk stability
- Flexible elastomer splash guard/seat ring protects seat and is removable for easy cleaning
- Built in anti-thrust seat helps maintain pelvic positioning
- Tumble Forms 2 brand high density foam has a washable, seamless coating that is urine and stain-resistant and nontoxic
- Lockable castor base facilitates safety with transfers

Carrie Potty Seat Includes

- Adjustable tray
- Height adjustable footrest
- Removable splash guard
- Adjustable headrest
- Hip and chest harness
- Removable footrest
- Removable bucket for use as a commode

Carrie Potty Seat				
Item Number	Size	Max User Height	Max User Weight	
2771P	Elementary	1250mm (48")	27kg (4 1/4st)	
2771J	Junior	1470mm (58")	45kg (7st)	£929.00
2771SA	Small Adult	1730mm (68")	59kg (9 1/4st)	

Spares Available

- 928260 Elementary Buckle End for Hip Strap
- 928261 Elementary Strap End for Hip Strap
- 928262 Elementary Complete Harness (Chest Pad and Buckle Strap)
- 928263 Elementary Splash Guard
- 928264 Elementary Tray
- 922774 Neck Brace - All Sizes
- 928371 Junior Splash Guard
- 928372 Junior Tray
- 928370 Junior Complete Harness (Chest Pad and Buckle Strap)
- 922771 Small Adult Complete Harness (Shoulder Straps, Buckle and Hip Straps)
- 922772 Small Adult Splash Guard
- 922773 Small Adult Tray

SPARES
Spares are available for these products, making them suitable for refurbishment. For full spares listing, please see pages 1353 to 1360.



Carrie Potty Seat Dimensions						
Item number	Overall width	Overall height	Inner seat height	Inner seat depth	Inner seat width	Overall seat Width
2771P	445mm	1080mm	660mm	250mm	250mm	370mm
2771J	480mm	1270mm	760mm	330mm	305mm	415mm
2771SA	580mm	1360mm	840mm	410mm	355mm	470mm



TRAY REMOVES FOR EASE IN TRANSFERRING



SPLASH GUARD REMOVES FOR EASY CLEANING



INCLUDES REMOVABLE BUCKET



BEST SELLER

1 Adjustable Paediatric Commode Homecraft

This brightly coloured commode has a durable powder coated steel frame and is supplied with a child's toilet seat, commode pan with lid and an adjustable strap. The plastic toilet seat has a front cut away aperture to allow personal hygiene. The commode is height adjustable and has a PU padded backrest for comfort and support. PU is a closed cell foam, which promotes hygiene and because there are no welded edges, fragile skin will not catch. Seat height adjusts from 280 to 355mm (11 to 14") with four height settings. Height of arms 420 to 496mm (16½ to 19½"). Overall width 430mm (17"). Overall depth 440mm (17¼"). Width between arms 380mm (15"). Toilet seat external width 324mm (12¾"). Internal seat width 171mm (6¾"). External seat depth 380mm (15"). Internal seat depth 325mm (12¾"). Aperture cut out 55mm (2¼"). Weight 5.5kg.

09 116 4656

Maximum user weight

100 kg **15¾ st**

2 Children's Toilet Seat

This children's toilet seat is height adjustable and has a steel frame lacquered with a strong powder coating. The seat is made of polypropylene which gives a soft, heat-isolated surface. The rubber feet are made of TPE, a soft plastic which does not mark floors. Removable commode pan is included. Suitable for use in an autoclave at 85°C for 3 minutes.

Seat Height	345-445mm (13½-17½")
Armrest Height	525-625mm (20¾-24½")
Inner Width	325mm (12¾")
Total Width	375mm (14¾")
Seat Depth	285mm (11¼")
Seat Width	250mm (9¾")
Aperture Width	165mm (6½")
Aperture Depth	195mm (7¾")

09 120 4866

Maximum user weight

70 kg **11 st**

3 Children's Potty Seat

This adjustable height potty seat gives a more secure feeling as the child is closer to the floor. It includes a removable pan and is supplied with lap and shoulder straps to offer additional support. It can be cleaned in an autoclave at 85°C max for 3 minutes.

	Small	Medium
Seat Height	195-280mm	220-305mm
Seat Width	200mm	230mm
Seat Depth	220mm	290mm
Aperture Width	120mm	140mm
Aperture Depth	160mm	180mm

09 120 4874 Small

09 120 4882 Medium

4 Potty Chair

Cleverly designed potty chairs that allow adjustment of seat height, depth and width. The larger chair's potty is suitable for children up to the age of 14. The chairs come complete with cushions, potty and hand rail. Available in Blue, Red or Green. Blue held in stock (Red and Green delivery time, 4 to 6 weeks).

AA75201SB	Small	Blue
AA75201SF	Small	Red
AA75201SG	Small	Green
AA75201MB	Medium	Blue
AA75201MF	Medium	Red
AA75201MG	Medium	Green
AA75201LB	Large	Blue
AA75201LF	Large	Red
AA75201LG	Large	Green

	Small	Medium	Large
Height	175-325mm	220-395mm	290-440mm
Width	280mm	325mm	420mm
Depth	285mm	350mm	400mm



1



TOILETING CHAIR WITH ADJUSTABLE ARMS

1



TOILETING CHAIR WITH FIXED ARMS

1 Combi Toileting Chair

A progressive toileting chair that is suitable for children from 18 months to 12 years. It can be used in three ways, as a chair, as a commode and as a potty. Available in two designs, with either fixed padded arms or adjustable arms. The wooden frame has a waterproof and anti-bacterial coating and the padding has a wipe clean vinyl covering. The plastic toileting seat is contoured to shape and designed for easy cleaning. The height and seat depth of the chair is adjustable. The upholstered seat is removable. All chairs are supplied complete with: pot and lid, seat and potty, buckle pelvic strap. Available in Blue, Red, Green or Yellow. Blue held in stock (Red, Green and Yellow delivery time, 4 to 6 weeks).

Combi Toileting Chair - Dimensions				
	X-S	S	M	L
Seat Width	290mm	325mm	365mm	435mm
Seat Depth	205-290mm	245-355mm	310-385mm	350-440mm
Floor to Seat Height	215-290mm	275-375mm	300-400mm	340-450mm
Back Height	325mm	370mm	400mm	500mm

Fixed Arms

- AA75133XSB** X-Small Blue
- AA75133XSF** X-Small Red
- AA75133XSG** X-Small Green
- AA75133XSI** X-Small Yellow
- AA75133SB** Small Blue
- AA75133SF** Small Red
- AA75133SG** Small Green
- AA75133SI** Small Yellow
- AA75133MB** Medium Blue
- AA75133MF** Medium Red
- AA75133MG** Medium Green
- AA75133MI** Medium Yellow
- AA75133LB** Large Blue
- AA75133LF** Large Red
- AA75133LG** Large Green
- AA75133LI** Large Yellow

Adjustable Arms

- AA75134XSB** X-Small Blue
- AA75134XSF** X-Small Red
- AA75134XSG** X-Small Green
- AA75134XSI** X-Small Yellow
- AA75134SB** Small Blue
- AA75134SF** Small Red
- AA75134SG** Small Green
- AA75134SI** Small Yellow
- AA75134MB** Medium Blue
- AA75134MF** Medium Red
- AA75134MG** Medium Green
- AA75134MI** Medium Yellow
- AA75134LB** Large Blue
- AA75134LF** Large Red
- AA75134LG** Large Green
- AA75134LI** Large Yellow

Accessories

- (Table Tray fits adjustable armed chairs only)
- AA75137XS** X-Small Table Tray
 - AA75137S** Small Table Tray
 - AA75137M** Medium Table Tray
 - AA75137L** Large Table Tray
 - AA75135XS** X-Small Toggle Handrail
 - AA75135S** Small Toggle Handrail
 - AA75135M** Medium Toggle Handrail
 - AA75135L** Large Toggle Handrail
- Plastic Splash Guard (Plastic Splash Guard can only be used with Toggle Handrail)
- AA75136XS** X-Small Splash Guard
 - AA75136S** Small Splash Guard
 - AA75136M** Medium Splash Guard
 - AA75136L** Large Splash Guard

1

HIGH BACK TOILET SUPPORT



LOW BACK TOILET SUPPORT

1 Toilet Support

Low Back Toilet Support

Ideal for children with balance deficiencies. The wraparound, height adjustable support yoke has a removable, adjustable safety belt for added stability. Use toilet seat bolts for mounting. Made of chrome plated steel and high-impact, white ABS plastic.

6230	Child	305mm (12") Wide 180-405mm (7-16") High
6231	Adult	355mm (14") Wide 255-430mm (10-17") High
6236	Optional Footrest/Armrest	
623601	Armrest - Only	

High-Back Toilet Support

The contoured back provides trunk and head support for children and young adults. Locks at any height from 455 to 610mm (18 to 24"). Includes adjustable harness and toilet seat reducer ring. Made of chrome plated steel and high impact, white ABS plastic. Base easily bolts to toilet for security.

6227	Child	369mm (14½") Wide 457-610mm (18-24") High
6228	Junior Adult	369mm (14½") Wide 457-610mm (18-24") High
6229	Adult	457mm (18") Wide 584-737mm (23-29") High
6236	Optional Footrest/Armrest	
623601	Armrest - Only	

Accessories

Seamless, waterproof padded support cushions, moulded for a perfect fit. Attach securely with Velcro brand hook and loop and wipe clean easily.

6370	Padded Cushion for 6229	
637001	Padded Cushion for 6230	
637002	Padded Cushion for 6231	
637003	Padded Cushion for 6227	
637004	Padded Cushion for 6228	

2 Nuvo Children's Toilet Frame

The children's toilet frame eases sit to stand transfer for the child. It is discreet and fits around both nursery and standard toilets. It is height adjustable with 'E' clips and has moulded padded armrests for additional comfort.

Width between arms	360mm (14")
Internal frame width	380mm (15")
Height	490-610mm (19-24")
Arm width	30mm (1½")
Maximum footprint	460 x 610mm (18-24")

09 120 4379

Maximum user weight **64 kg** **10 st**

2



1 Svan Balance Toilet Frame

The Svan Balance Toilet Frame allows children and small adults to sit securely while going to the toilet. The frame provides support for children with limited mobility without getting in the way of other members of the family. It can switch quickly from a secure support to an easily accessible toilet for parents.

The toilet frame is made from coated stainless steel to withstand the bathroom environment without corrosion. Armrests are also padded for additional comfort. The armrests are height adjustable with three settings and the footrest can be adjusted to four different heights to ensure proper leg support. The height is easily adjusted using a simple handle, with no tools required.

09 116 2759 Frame with Armrest Surround and Footrest

09 116 2767 Frame with Duo Armrest and Footrest

09 116 2775 Frame with Straight Armrests, Grab Rails and Footrest

09 117 6064 Back Cushion



FRAME WITH ARMREST SURROUND AND FOOTREST



FRAME WITH DUO ARMREST AND FOOTREST



FRAME WITH STRAIGHT ARMRESTS, GRAB RAILS AND FOOTREST



FRAME WITH STRAIGHT ARMRESTS, GRAB RAILS AND FOOTREST

Specifications	09 116 2759	09 116 2767	09 116 2775
Frame to back of Toilet	450mm	450mm	450mm
Armrest Length	360mm	360mm	360mm
Width between Armrests	425mm	350/500mm	425mm
Armrest Height from Toilet Seat	220-270mm	220-270mm	220-270mm
Toilet Seat to Footrest	200-365mm	200-365mm	200-365mm
Grab Rail Height	-	-	570-810mm
Grab Rail Handle Length	-	-	240mm
Edge of Grab Rail to back of Toilet	-	-	630mm
Footrest Width	400mm	400mm	400mm
Footrest Depth	260mm	260mm	260mm
Edge of Footrest to back of Toilet	630mm	630mm	630mm
Footrest Max User Weight	60kg	60kg	60kg
Grab Rail Max User Weight	130kg	130kg	130kg

1



1 Children's Portable Toilet Seat

This portable stable toilet seat has a reduced ring aperture with arms and a backrest to provide additional support for children when going to the toilet. The seat attaches easily to the toilet by clipping onto the existing seat and needs no extra adjustments or tools. Available with a standard or cut-out seat.

Total seat depth	340mm (13 1/2")
Total seat width	450mm (17 3/4")
Aperture depth	200mm (7 3/4")
Aperture width	170mm (6 3/4")
Weight	6.2kg

09 116 4664 Toilet Seat Standard

09 116 4672 Toilet Seat Cutout

2 High Back Children's Toilet Seat

A stable and safe toilet seat made of plastic. The seat allows the child to sit straight and a pair of easily adjustable shoulder straps offer additional support. The seat also features an armrest and splashguard. A hook and butterfly nut placed at the back of the backrest fixes the seat to the toilet. The hook is then adjusted and locked so you don't have to unscrew it when the toilet seat is lifted off. It can be cleaned in an autoclave at a maximum of 85°C for 3 minutes or washed using a mild detergent pH 5-9.

Specification	Small	Medium	Large
Overall Seat Depth	220mm	290mm	340mm
Overall Seat Width	200mm	230mm	340mm
Aperture Depth	160mm	180mm	220mm
Aperture Width	120mm	140mm	170mm

09 115 9524 Small

09 115 9532 Medium

09 115 9540 Large

2



3 Low Back Children's Toilet Seat

This stable seat has a low back that supports the child helping them to sit up straight. It has a waist belt that is easy to adjust and the seat also features a splashguard. The small and large sizes are fixed with a nylon strap, which is tightened around the toilet. The medium size is fixed to the toilet with a hook and butterfly nut placed at the back of the backrest. It can be cleaned in an autoclave at a maximum of 85°C for 3 minutes or washed using a mild detergent pH 5-9.

Specification	Small	Medium	Large
Overall Seat Depth	220mm	290mm	340mm
Overall Seat Width	200mm	230mm	340mm
Aperture Depth	160mm	182mm	220mm
Aperture Width	120mm	140mm	170mm

09 115 9557 Small

09 115 9565 Medium

3



1 Padded Toilet Seat Reducer

This contoured seat has a lifted back, which reduces the chance of the user sliding. A recessed slot allows the splash guard (89mm) to smoothly slide on and off the seat. The padded seat is vinyl covered and fits standard and elongated seats. Inner bowl 170 x 190mm (6¹/₂ x 7¹/₂" diameter). Overall 370 x 390mm (14¹/₂ x 15¹/₂").

09 116 0498

2 Family Toilet Seat

A durable white toilet seat made from tough polypropylene plastic. It combines a standard adult toilet seat with a fold down child size toilet seat to reduce the toilet seat size and provide secure seating for the child. It is designed to help to train children to use the toilet and is very easy to use. Fits easily onto most standard toilets, replacing the existing seat. Hygienic and easy to clean. Aperture size of child seat is 170 x 215mm (6³/₄ x 8¹/₂").

09 115 6256

£26.95

3 Toilet Seat Reducer Ring

Durable ivory plastic ring easily fits onto toilet bowl, reducing size of the toilet seat area and providing secure seating. Fits most standard toilets. Inner measurement: Length 205mm (8"). Width 150mm (6").

622801

4 Soft-Flex Splash Guard

Soft and flexible for comfort and safety. Installs quickly and easily onto standard toilet seats. Cleans easily in soapy water or autoclave. Height 140mm (5¹/₂"). Width 150mm (6"). Deflector is 110mm (4¹/₂") and has a 19mm (3/4") dip, to close gap between seat and bowl.

6232

5 Savanah Splash™ Sentry

Homecraft

Simple to fit, the Savanah Splash Sentry clips to a toilet bowl, a raised toilet seat or a toilet frame with a peg-like action. Prevents embarrassing and unhygienic accidents that can happen, for example, when children sit down to use the toilet. From a seated position the guard deflects urine down into the toilet. Simple to remove for cleaning and for getting on and off the toilet. Height 210mm (8¹/₄"). Width 140mm (5¹/₂"). Deflector is 185mm (7¹/₄").

AA2602





1



PICTURED WITH SENSORY SIMULATION BOWL



PICTURED WITH ART EASEL

1 Convert-Able Table

A multi-purpose and adaptable melamine table that is appropriate for both children and adults. The Convert-Able Table is a fully integrated system where children (and adults) can participate in work, play and leisure. Designed for ease of use and versatility, it can be used with wheelchairs, standing frames, gait trainers and other seating systems. It comes with a large desktop work surface with 0° to 90° of tilt. It is constructed from 38mm (1 1/2") powder coated tubular steel and comes with four dual locking castors. The table measures 533 to 940mm (21 to 37") high with 685 x 787mm (27 x 31") desktop. The outer frame measures 737 x 763mm (29 x 30"). Adjusts by push button pneumatic assist.

7051

09 120 3637 Sensory Stimulation Bowl

09 120 3645 Art Easel

Maximum user weight



2 Variheight Table

The Variheight Table is manufactured to an optimum size for most environments, whether for single use or in a group. It is fully adjustable in height, enabling it to suit users of differing ages and circumstances. Low gearing and a detachable handle make height adjustment easy without removing any article from the tabletop. The table frame is made from heavy duty steel with a grey nylon epoxy coating. The tabletop is covered in a yellow melamine coating for added protection. The table is available in two models, the standard version or the lowline version.

Both models are available with a plain flat surface or a tilt top version.

Dimensions

Standard Model

AA75313S Flat Top Version

09 116 8137 Tilt Top Version

Tabletop size 914 x 762mm (36 x 30")

Height adjustment range 610-914mm (24-36")

Lowline Model

AA75313L Flat Top Version

09 116 8145 Tilt Top Version

Tabletop size 914 x 762mm (36 x 30")

Height adjustment range 305-686mm (12-27")



2

STANDARD



2

TILT TOP

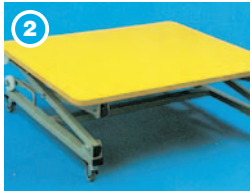

2

LOW MODEL



3

3 Personal Table

Ideal for individual use where space is tight and work articles are not excessively heavy. The table has three lipped edges, is mobile with lockable castors and is adjustable in height. The table is available in two models, the standard version or the high version.

Both models have a plain, flat surface with three edges being lipped. A tilt top variation is available for both models. (Tilt top angles to 30° and 45°).

Dimensions

Standard Model

AA75314S Flat Top Version

09 116 8111 Tilt Top Version

Tabletop Size 685 x 545mm (27 x 21 1/2")

Height Adjustment Range 430-735mm (17-29")

High Model

AA75314H Flat Top Version

09 116 8129 Tilt Top Version

Tabletop Size 685 x 545mm (27 x 21 1/2")

Height Adjustment Range 685-1220mm (27-48")



DELIVERY

Delivery is approximately 3 to 4 weeks. Please contact Customer Services for more information.

1 SKM Easywind™ Table

The Easywind Table is an incredibly flexible, height adjustable table. It has an adjustable angled surface with lip and tilt safety lock which holds table in flat position. It features twin wheels that lock, ensuring that the table will not slip or pivot, leaving the user free to concentrate on the activity at hand. Available in standard or junior versions. Width 60cm. Tilt 0° to 70°.

		Length	Height Adjustment
09 132 0639	Standard	90cm	60cm - 86cm
09 132 0647	Junior	90cm	52cm - 66cm



2 SKM Easywind™ Activity Tilt Table

The Activity Easywind Tilt Table is an incredibly flexible, height adjustable table. It features a stainless steel basin that can be used for water play with a lockable timber infill for when the basin is not in use. The table has an adjustable angled surface with lip, and twin wheels that lock, ensuring that the table will not slip or pivot, leaving the user free to concentrate on the activity at hand. Available in standard or junior versions. Length 90cm. Width 60cm. Tilt 0° to 40°.

		Height Adjustment
AA95094	Standard	60-86cm
AA95095	Junior	52-66cm



3 SKM Easywind™ Split Top Table

With all the functions of the standard Easywind Table, this table features a tilting mid-section which enables the right or left hand access to paints or books whilst using the tilt top, making it ideal for reading, writing or art work etc. Available in standard or junior versions.

Length 90cm (20+50+20). Width 60cm. Tilt 0° to 70°.

		Height Adjustment
09 132 0969	Standard	60cm - 86cm
09 132 0977	Junior	52cm - 66cm



4 SKM Easywind™ Table with Cut-out

With all the functions of the Easywind Table, this table facilitates close-in access and allows for extra upper body and arm support. Available in standard or junior versions.

Length 90cm. Width 60cm. Tilt 0° to 70°. Cut-out 50cm x 15cm.

		Height Adjustment
09 132 0985	Standard	60cm - 86cm
09 132 0993	Junior	52cm - 66cm



5 SKM Easywind™ Joystick Access Table

With all the functions of the Easywind Table, this larger Easywind Table features unique joystick access removable timber infills on both the right and left hand sides. It facilitates close in access for powered wheelchairs and is strong yet lightweight and easily moved.

Length 1200cm. Width 60cm. Tilt 0° to 70°.

		Height Adjustment
09 132 1009	Standard	60cm - 86cm
09 132 1017	Junior	52cm - 66cm



MADE TO ORDER
All items on this page are made to order and, therefore, are not refundable.

DELIVERY
Delivery is approximately 4 to 6 weeks. Please contact Customer Services for more information.



1 Easywind™ Group Table

This multi-purpose table is ideal for a range of activities including craftwork, dining, classroom activities and computer work and the special hardwearing laminate finish tabletop makes it easy to clean. It can be accessed by a number of seated users and is height adjustable via use of an easy-to-use wind-up crank handle. Locking wheels aid transport when the table is not in use. Available in a standard or junior version. Length 160cm. Depth 85cm. Height of standard table 60 to 86cm. Height of junior table 52 to 66cm.

AA95093 Junior



2 SKM Easywind™ Four Leg Circular Group Table

With all the functions of the Easywind Table and big enough for four wheelchair users, this table is ideal for dining and activities. Available in standard or junior versions. This table does not have a tilting top facility. Diameter 150cm. This table does not have a tilting top facility. Length 160cm. Width 105.5cm.

Height Adjustment

09 132 1140 Standard 54cm - 80cm

09 132 1157 Junior 43cm - 58cm



3 SKM Easywind™ Four Leg Group Table

With all the functions of the Easywind Group Table, this spacious sturdy table is multi functional. The table enables access for 4 wheelchair users. Available in standard or junior versions. This table does not have a tilting top facility. Length 160cm. Width 105.5cm.

Height Adjustment

09 142 3748 Standard 54cm - 80cm

09 142 3755 Junior 43cm - 58cm

4 SKM Easywind™ Dual Level Work Table

This innovative table is designed to enable the integration of wheelchair users with their peers. Because the table has two halves that are independently height adjustable, it is suitable to use with wheelchairs and standard chairs, and for children with bigger or smaller growth. Height 60 to 86cm. Length 120cm. Depth 38cm.

AA95096C



 **MADE TO ORDER**
All items on this page are made to order and, therefore, are not refundable.

 **DELIVERY**
Delivery is approximately 4 to 6 weeks. Please contact Customer Services for more information.

1 SKM 100 Easystore™ Spacesaver

The SKM 100 Easystore™ Spacesaver Table is operated by a press button control with battery back-up, allowing for use away from the main power supply without trailing cables. Robust space saving design for ease of storage, the table top tilts to a vertical position and is fitted with a locking system for safety. Available in standard or junior versions with beech finish and locking castors. Length 165cm, 200cm or 240cm. Depth 105cm.

	Length	Size	Height Adjustment
09 132 1025	165cm	Standard	67cm - 100cm
09 132 1033	200cm	Standard	67cm - 100cm
09 132 1041	240cm	Standard	67cm - 100cm
09 132 1058	165cm	Junior	52cm - 72cm
09 132 1066	200cm	Junior	52cm - 72cm
09 132 1074	240cm	Junior	52cm - 72cm



2 SKM Easystore™ Therapy Table

The SKM Easystore™ Therapy Table is operated by a press button control with battery back-up, allowing for use away from the main power supply without trailing cables. Robust space saving design makes this therapy table ideal where space is limited as it stores away in a vertical position. The folding function and four locking castors make movement between rooms quick and easy.

Total wheelchair access. Available in standard or junior versions. Length 165cm, 200cm or 240cm. Depth 90cm. Cut-out 50cm x 15cm.

	Length	Size	Height Adjustment
09 132 1082	165cm	Standard	67cm - 100cm
09 132 1090	200cm	Standard	67cm - 100cm
09 132 1108	240cm	Standard	67cm - 100cm
09 132 1116	165cm	Junior	52cm - 72cm
09 132 1124	200cm	Junior	52cm - 72cm
09 132 1132	240cm	Junior	52cm - 72cm



MADE TO ORDER
All items on this page are made to order and, therefore, are not refundable.

DELIVERY
Delivery is approximately 4 to 6 weeks. Please contact Customer Services for more information.



1 Adjustable Therapy Benches Homecraft

These Adjustable Therapy Benches are ideal for use by therapists or parents when working with children who do not require back support. The height is easy to adjust and the seat can be tilted, which places more weight on the child's feet and aids postural control. Available in two sizes.

	Width	Length	Height
09 120 7232 Small	270mm	660mm	180 - 280mm
09 120 7240 Large	360mm	800mm	270 - 430mm

Maximum user weight **100 kg** **15³/₄ st**

2 Mobile Therapy Stool Homecraft

This Therapy Stool is designed for use by therapists, teachers or parents when working with children. The stool has a padded seat with a colourful vinyl covering to aid compliance. The height is adjustable from 340-460mm (13-18") and the stool has lockable castors for added security. Measures 450 x 370mm (17³/₄" x 14¹/₂")

09 120 6887

Maximum user weight **100 kg** **15³/₄ st**

3 Therapy Benches

These therapy benches have adjustable height and are designed to angle along or across the bench surface. They are available in three sizes and two widths. The ends have a side slot for easy, safe and positive adjustment.

Short	Height	Length	Width
AA75315N	195-295mm	610mm	250mm
AA75315W	195-295mm	610mm	300mm
Medium			
AA75316N	280-455mm	820mm	300mm
AA75316W	280-455mm	820mm	380mm
High			
AA75317N	415-705mm	820mm	325mm
AA75317W	415-705mm	820mm	380mm

4 Wheely Therapy Stool

Designed for use by therapists, teachers and parents when working at floor level with children. They are adjustable in height to suit the individual and for stability. They should be used by sitting astride the narrower side.

Available with a Red seat or a Green seat. Height 340-460mm (13 to 18"). Length 450mm (17¹/₂"). Width 370mm (14¹/₂").

AA75312F Red
AA75312G Green

5 Therapy Stool and Bench

To be used by therapists, teachers and parents, these stools and benches are padded, mobile and height adjustable. Stools are available with or without lockable castors.

Therapy Stool

490 x 540mm, height adjustment 360-460mm.

AA75362 Swivel Castors
AA75363 Lockable Castors

Maximum user weight **80 kg** **12¹/₂ st**



1 Special Tomato™ Soft-Touch™ Liners

The Special Tomato™ Soft-Touch™ Liners are soft and supportive providing a comfortable alternative seating solution for use in a variety of environments. Made of a latex-free seamless material, Soft-Touch™ Liners are peel and tear-resistant, impermeable to fluids and soft, yet durable. The durable Soft-Touch™ material withstands cracking, is anti-microbial, and cleans easily with common disinfectants.

Features

- Portable and durable
- Suitable for use in pushchairs, chairs, and wheelchairs
- Easy to clean
- Portable & lightweight
- Fits many chair options
- Positioning straps included
- Strap together for easy transportation

Specifications	Small	Medium	Large
Inner Seat Width	203mm	254mm	305mm
Inner Seat Depth	203mm	254mm	305mm
Total Seat Width	267mm	318mm	394mm
Total Seat Depth	267mm	318mm	394mm
Inner Back Width	191mm	216mm	254mm
Total Back Width	267mm	311mm	337mm
Back Height	254mm	343mm	368mm

	Size	Cherry	Lilac
Seat Cushion	Small	09 116 4979	09 118 2351
Back Cushion	Small	09 116 4987	09 118 2369
Seat Cushion	Medium	09 116 4995	09 118 2377
Back Cushion	Medium	09 116 5000	09 118 2385
Seat Cushion	Large	09 116 5018	09 118 2393
Back Cushion	Large	09 116 5026	09 118 2401

2 Special Tomato™ Soft-Touch™ Booster

Special Tomato® Soft-Touch® Cushions are also available in a child booster seat available in two colour choices: Cherry & Lilac/Pink.

The Special Tomato Soft-Touch Booster Seat was designed for children who have good head strength and can sit unassisted. It is intended to elevate the seating surface of children who have minimal seating needs. The comfortable, supportive, and portable seat is made from soft-to-touch material that is latex-free and anti-microbial. It has a contoured seat surface with an integratedommel promoting proper sitting posture, and the attachment strap can secure the seat to a standard dining room, restaurant, or classroom chair, as well as a carry strap.

09 120 6119 Cherry
09 120 6135 Lilac



INFORMATION
The Special Tomato Soft-Touch Booster has not been crash-tested and CANNOT be used as a car seat booster.



1 Breezi High Chair

The Breezi High Chair is designed to promote independence and integration. It is easily adjusted to suit all requirements simply by loosening the retaining screws and moving the seat and footplates to the required height and depth. The Breezi Chair is supplied flat packed and some self assembly is required. Height 780mm (31"). Width 470mm (19"). Depth 570mm (23").

AA75324



2 Teezi Breezi Low Chair

As with the Breezi High Chair, the Teezi Breezi Low Chair is easily adjusted to suit different requirements and has the added advantage of fitting under standard school tables. It is the perfect height for using computers and the support given helps with eating and drinking. The Teezi Breezi Low Chair is supplied flat packed and some self assembly is required. Height 550mm (22"). Width 430mm (17"). Depth 540mm (21 1/2").

AA75325



3 Breezi Max High Chair

A larger version of the Breezi High Chair suitable for adolescents and small adults. The chair is height adjustable and accommodates up to a breakfast bar height. Seat: Width 450mm (17 3/4"), Depth 350mm (13 3/4"), Height 750mm (29 1/2") max.

09 116 4698

Maximum user weight



4 Accessories

A wide range of accessories are available for the Breezi and Teezi Breezi Chair. The chairs are supplied flat packed without any holes pre-drilled in them for attaching accessories. Colours may vary to those pictured.

Chest Strap

Two 100mm (4") chest straps are available. The Freestanding chest strap attaches directly to the chair whilst the Corner Back chest strap attaches to the Wide Corner Back.

AA75326	Freestanding Chest Strap	
AA75326C	Chest Strap for Corner Back	
AA75327	Tray	Breezi
AA75327TB	Tray	Teezi Breezi
09 115 6264	Wide Corner Back and Padding	
AA75330	45° Pelvic Strap	
AA75331S	Footshoes	Small
AA75331L	Footshoes	Large
AA75332	Footrest	Standard
AA75332EX	Footrest	Extended
AA75333	76mm (3") Diameter Pommel	
AA75334	Mobile Base	Breezi
AA75334TB	Mobile Base	Teezi Breezi
AA75335	Head Support	
AA75336	High Back Pad	
AA75339	Seat Cushion	Small
AA75340	Seat Cushion	Large
09 116 8160	Seat with Thigh Pads	
AA75342	Ski's with Castors	Breezi
AA75343	Ski's with Castors	Teezi Breezi
09 118 7558	Freestanding Breezi Max Chest Strap	
09 118 7566	Tray	Breezi Max
09 118 7574	45° Pelvic Strap	Breezi Max
09 118 7590	Pommel	Breezi Max
09 118 7608	Mobile Base	Breezi Max
09 118 7616	High Back Pad	Breezi Max



INFORMATION

The Breezi and Teezi Breezi Chairs are supplied flat packed and some self assembly is required. The chairs are supplied without any holes pre-drilled in them for attaching accessories. We recommend that the holes are drilled by a qualified tradesman.

1 Special Tomato® Height Right™ Chair

The Height Right™ Chair provides stylish, comfortable seating at home or school. The design encourages interaction with peers, while providing minimal to moderate support for the child. The Height Right™ chair has a solid adjustable footrest that gives the child a safe and secure platform for proper positioning of the legs and feet. The seat and footrest adjust in height and depth, allowing the chair to "grow" with the child throughout the years. For mealtimes and tabletop activities, the Height Right™ chair is the perfect seating solution for children of all ages. Optional Padded Cushions and a contoured backrest for the seat are made from a wipe-clean Soft-Touch™, seamless material. For children that need more lateral support, the Soft-Touch™ cushions attach easily to the Height Right™ chair. The Optional Wooden Tray offers a stable surface for children that use their arms to help stabilise their trunk, as well as a suitable feeding solution.

Features

- 3-Point Pelvic Belt
- Adjustable Foot and Seat Plate

09 115 8575 Height Right Chair

Accessories

09 116 4334 Adjustable Wooden Tray

09 116 4953 Grab Rail

09 116 4946 Seat Cushion Cherry

09 118 2450 Seat Cushion Lilac/Pink

09 131 5274 Seat Cushion Chocolate **NEW**

09 116 4961 Back Cushion Cherry

09 118 2468 Back Cushion Lilac/Pink

09 131 5282 Back Cushion Chocolate **NEW**

Maximum user weight



Specifications	
Seat Width	419mm (16 1/2")
Seat Height Range (from floor)	419-610mm (16 1/2-24")
Foot Plate Width	419mm (16 1/2")
Foot Plate Height Range (from floor)	102-381mm (4-15")
Tray Height (from floor)	660mm (26")
Overall Height	838mm (33")
Overall Width	432mm (17")
Overall Depth	533 (21")

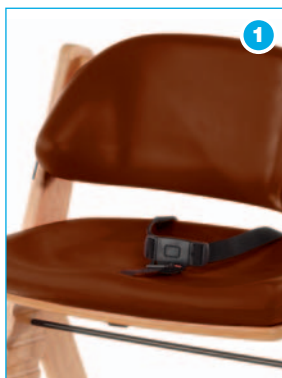
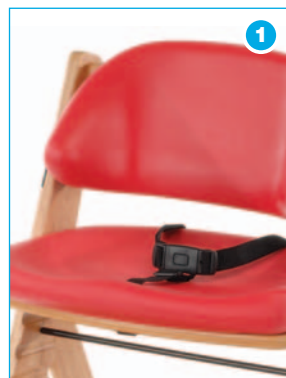



1 PAL Classroom Seating System

Designed by a team of experienced therapists and engineers, Pal is an attractive, robust and easy to use classroom and nursery seating system for kids of 1-8 years of age, with mild to moderate postural needs. It is designed to give improved stability, which helps reduce fatigue and allows the child longer periods of concentration and fine motor activity. Available in three sizes and four colours it will help kids up to 8 years of age to participate, learn and give their full attention in the classroom.

Created for self assessment

The simplicity of Pal enables the therapist to assess the child's needs, instantly order their Pal Classroom Seat and quickly and easily set up the product when it arrives. Pal really is the simple, fast way to help kids join in with learning.

Pal is a self assessment product where you assess the size required by 3 simple measurements:

- 1. Seat depth 2. Seat width 3. Seat height**

Available in 3 sizes and in 4 colours: green, orange, blue and pink.

PAL Seat Codes:

	Small	Medium	Large
Green	09 132 2163	09 132 7345	09 132 7352
Orange	09 132 7360	09 132 7378	09 132 7386
Blue	09 132 7394	09 132 7402	09 132 7410
Pink	09 132 7428	09 132 7436	09 132 7444

Price

Accessories (suitable for all colours)				
	Small	Medium	Large	
Skis with Castors	09 132 7451	09 132 7469	09 132 7477	
Rocker/Stabilisers	09 132 7485	09 132 7493	09 132 7501	
Footrest	09 132 7527	09 132 7543	09 132 7550	
Activity Tray	09 132 8319	09 132 8335	09 132 8681	
High Seat Frame	09 132 7519	N/A	N/A	

Accessories (colour specific)				
	Small	Medium	Large	
25mm Side Pad				
Green	09 132 7642	09 132 7667	09 132 7675	
Orange	09 132 7725	09 132 7741	09 132 7774	
Blue	09 132 7782	09 132 7790	09 132 7808	
Pink	09 132 7816	09 132 7824	09 132 7832	
50mm Side Pad				
Green	09 132 7840	09 132 7857	09 132 7865	
Orange	09 132 7873	09 132 7899	09 132 7907	
Blue	09 132 8251	09 132 8269	09 132 8277	
Pink	09 132 8285	09 132 8293	09 132 8301	
Pommel				
Green	09 132 8699	09 132 8707		
Orange	09 132 8715	09 132 8723		
Blue	09 132 8731	09 132 8749		
Pink	09 132 8756	09 132 8764		
Ramped Seat Cushion				
Green	09 132 8772	09 132 8806	09 132 8814	
Orange	09 132 8822	09 132 8830	09 132 8848	
Blue	09 132 8855	09 132 8863	09 132 8871	
Pink	09 132 8889	09 132 8897	09 132 8905	

Specifications			
	Small	Medium	Large
Age Range	1-3 years	2-5 years	4-8 years
Stature Range	700-950mm	900-1050mm	1000-1300mm
Seat Depth	180-240mm	220-290mm	250-330mm
Seat Width	150-250mm	170-270mm	230-330mm
Seat Height	160-240mm	185-285mm	250-350mm
Backrest Height	265mm	315mm	380mm
Seat Weight	4.3kg	6kg	8.2kg
Max User Weight	30kg (4 ³ / ₄ st)	35kg (5 ¹ / ₂ st)	40kg (6 ¹ / ₄ st)



DELIVERY
Delivery is approximately 4 to 6 weeks.
Please contact Customer Services for more information.



HIGH SEAT FRAME



POMMEL



ACTIVITY TRAY



RAMPED SEAT CUSHION

HEATHFIELD CHAIR WITH ADJUSTABLE ARMS



HEATHFIELD CHAIR WITH FIXED ARMS WITH POMMEL, LUMBAR PAD AND SKI'S



HEATHFIELD CHAIR ADJUSTABLE ARMS WITH 4 POINT HARNESS, FOOTPLATE STRAPS AND WHEELED DOLLY/MODULE BASE



HEATHFIELD CHAIR WITH ADJUSTABLE ARMS WITH TRAY, TRAY HAND RAIL, HIGH BACK AND KICKING BOARD

The Heathfield chair range is designed for good postural sitting with minimum support. The low chair is available with feet on the floor, a wheeled dolly, footrest or footplate for children with moderate to medium seating requirements. The chairs are suitable for use both in the classroom and at home and can be used at a table or with a tray fitted. The seat height and depth are both easily adjustable to cater for the child's needs. Available with either fixed or adjustable arms in six sizes to suit children from 18 months to adult. A range of accessories are also available. Please contact Customer Services for more information.

Chair Options

Size	Measurement H x W x L Dimensions in mm	Adjustable Arms	Fixed Arms
1	190-240 x 240 x 180-240	AA7530801	AA7530811
2	210-310 x 280 x 220-310	AA7530802	AA7530812
3	270-345 x 325 x 260-340	AA7530803	AA7530813
4	310-410 x 365 x 320-410	AA7530804	AA7530814
5	350-450 x 435 x 375-475	AA7530805	AA7530815
6	400-500 x 435 x 450-550	AA7530806	AA7530816

Accessories

Description	1 (Green) ●	2 (Red) ●	3 (Blue) ●	4 (Green) ●	5 (Red) ●	6 (Blue) ●
Pommel	AA7535001	AA7535002	AA7535003	AA7535004	AA7535005	AA7535006
Lumbar Pad	AA7535101	AA7535102	AA7535103	AA7535104	AA7535105	AA7535106
Buckle Strap	AA7535201	AA7535202	AA7535203	AA7535204	AA7535205	AA7535206
Tray / Table	AA7535301	AA7535302	AA7535303	AA7535304	AA7535305	AA7535306
Tray Hand Rail	AA7535401	AA7535402	AA7535403	AA7535404	AA7535405	AA7535406
Footboard	AA7535501	AA7535502	AA7535503	AA7535504	AA7535505	AA7535506
Footplate and Straps	AA7535601	AA7535602	AA7535603	AA7535604	AA7535605	AA7535606
Four Point Harness	AA7535701	AA7535702	AA7535703	AA7535704	AA7535705	AA7535706
Wheeled Dolly	AA7535801	AA7535802	AA7535803	AA7535804	AA7535805	AA7535806
Ski's	AA7535901	AA7535902	AA7535903	AA7535904	AA7535905	AA7535906
High Back	AA7536001	AA7536002	AA7536003	AA7536004	AA7536005	AA7536006
Kicking Board	AA7536101	AA7536102	AA7536103	AA7536104	AA7536105	AA7536106



Tumble Forms 2™
With Anti-Microbial Protection

1 Tumble Forms 2™ Universal Corner Chair Sammons Preston

This positioning alternative keeps the child's shoulders flexed to help better focus on fine motor activities. The Corner Chair also helps maintain leg extension and reduces extensor thrust. Chair padding allows child to maintain sitting position for longer periods. One size fits children to adolescents with a maximum height of 1520mm (60"). Back height 480mm (19"), base 500 x 710mm (20 x 28").

Universal Corner Chair Features

- Broad base helps prevent tipping
- Integral abductor block supports the removable tray
- Tray is removable and adjustable to 30°
- Includes hip positioning belt and height adjustable H-harness
- Washable, stain and urine-resistant and non-toxic

4590U

Spares Include

- 4542H** H-Strap
9110 Bucklestrap
924590 Tray



2 Corner Chair Homecraft

This simple corner chair keeps the child's shoulders flexed in a long sitting position and helps maintain leg extension. It provides support at the back and sides of the child and is useful for children that are developing sitting balance. The adjustable and removable pommel helps keep the legs abducted which is useful for children who find it difficult to sit with their legs out in front of them. Includes a hip positioning belt and adjustable H-harness. The padded vinyl cushions are comfortable and easy to clean with an anti-microbial coating. Seat Depth 290mm (11 1/2"). Seat Width 430mm (17"). Seat Back Height 450mm (17 3/4"). Overall Dimensions 550 x 600mm (21 3/4 x 23 3/4").

- 09 142 3599** Small
09 142 3607 Large
09 120 4411 Table Tray



3 Seat-2-Go Positioning Seat

This lightweight soft padded positioning seat is ideal for children that need support while sitting on the floor or on a chair. It is simple to use in a home, school or when travelling. The contoured seat prevents the child from sliding forward and improves seating posture. It has a 95° seat to back angle and double strap trunk support and belt. The fastening straps secure the seat to any chair and can be stored in the back pocket when not in use. It can also be used as an insert for a pushchair. The Seat-2-Go also has a height adjustable headrest and a depth adjustable abductor available as accessories.

- 09 117 3988** Seat-2-Go Small
09 117 3996 Seat-2-Go Large

Accessories

- 09 117 4002** Headrest
09 117 4010 Abductor

Specifications

	Small	Large
Seat Width	203mm	305mm
Seat Depth	229mm	305mm
Seat Height	305mm	356mm
Weight	2.3kg	3.2kg
Maximum user weight	22.5 kg	34 kg
	3 1/2 st	5 1/4 st

SPARES
 Spares are available for these products, making them suitable for refurbishment. For full spares listing, please see pages 1353 to 1360.

1 First Class Chair

This adjustable chair is designed to provide good seating posture and support for children in the classroom, clinic or at home. It is suitable for children with mild to moderate seating requirements and has multiple adjustments and accessories to meet the needs of the child as they grow and develop. The chair is available in two sizes and its standard features include:

- Height and depth adjustable seat with a 15° anterior or posterior tilt
- Height and width adjustable armrests
- Adjustable pelvic belt to maintain proper seat position

Optional Accessories include

- Support Kit that includes an H-belt, height and depth adjustable abductor wedge and height and width adjustable lateral supports
- Adjustable height tray
- Height and depth adjustable two-piece flip up footplate with heel loop
- Height, depth and angle adjustable headrest that rotates and can be placed off centre
- Width adjustable Hip Guides
- Anti-tippers that provide additional stability when the child is seated with posterior tilt
- Four wheel Mobility Base to safely transport the child

09 117 4465 First Class Chair Small

09 117 4473 First Class Chair Large

09 117 4481 Support Kit (fits both)

09 117 4499 Tray Small

09 117 4507 Tray Large

09 117 4515 Footrest Small

09 117 4523 Footrest Large

09 117 4531 Headrest

09 117 4549 Hip Guides

09 117 4556 Anti-tippers Small

09 117 4564 Anti-tippers Large

09 117 4580 Mobility Base Small

09 117 4598 Mobility Base Large

Specifications		
	Small	Large
Seat Width	300mm	410mm
Seat Depth	230 - 360mm	330 - 430mm
Seat to Floor	230 - 330mm	360 - 580mm
Seat to Footplate	150 - 300mm	150 - 560mm
Back Height	380mm	430mm
Seat to Lateral Height	38 - 150mm	38 - 230mm
Seat to Armrest Height	38 - 240mm	38 - 290mm
Headrest (adds height of:)	110 - 200mm	110 - 200mm
Hip Guides	100 x 230mm	100 x 230mm
Seat to top of armrest	130 - 230mm	170 - 350mm
Laterals	100 x 130mm	100 x 130mm
Maximum User Weight	45kg	90kg



PICTURED WITH OPTIONAL TRAY, FOOTREST AND SUPPORT KIT



PICTURED WITH MOBILITY BASE, HEADREST, FOOTREST AND SUPPORT KIT



1



1 Nandu Chair

Nandu is a small seat for active children. Nandu will support active children who need a little help to join in the fun whether at school or at home. It is easier to stay alert if you are comfortable, which is why the Nandu seat is padded and adjustable for a perfect fit. The Nandu is available in four sizes each with up to 17cm continuous height adjustment and up to 8 degrees of forward tilt. The backrest can be reversed to provide chest support when in the forward leaning position. This design will help children sit up to work without having to work to sit up.

Features

- Compact seating for home or classroom
- Smooth and accurate height adjustment
- Dual use chest or back support
- Forward tilt for functional seating position
- Full range of accessories available

- 09 118 9505** Small
09 118 9513 Medium
09 118 9539 Large
09 118 9547 X-Large

Accessories

- 09 118 9554** Push Brace
09 118 9562 Hip Belt Small
09 118 9570 Hip Belt Medium
09 118 9596 Hip Belt Large
09 118 9604 Hip Belt X-Large
09 118 9612 Foot Plate Small
09 118 9638 Foot Plate Medium
09 118 9646 Foot Plate Large
09 118 9653 Foot Plate X-Large
09 118 9661 Foot Bar Small
09 118 9679 Foot Bar Medium
09 118 9687 Foot Bar Large
09 119 0982 Foot Bar X-Large

2



Maximum user weight



2 Straddler Bolster Chair

The Straddler Bolster Chair was designed as a seating choice for individuals whose legs tend to adduct. It promotes sitting in an upright position, increases the hip to back angle and permits the pelvis to tilt anteriorly. It assists with sit to stand activities and encourages independence in getting on and off the chair.

Features

- Height and angle adjustable seat – height adjustable in 5 increments
- Pelvic stabilizer – width and depth adjustable
- Pelvic belt
- Knee pads
- Foot rails – provide feet and lower leg alignment. Can be lifted up if not needed

Specifications

- Seat depth 343 - 483mm (13¹/₂" - 19")
 Seat height 241 - 419mm (9¹/₂" - 16¹/₂")
 Distance between laterals on pelvic stabilizer 127 - 229mm (5" - 9")
 Product weight 5³/₄kg

09 142 3557

Maximum user weight



1 Zebra Positioning Chair

The Zebra chair was designed for children who are unable to sit independently and it can be used at home, in hospitals, schools and rehabilitation centres. The brightly coloured upholstery and attractive design make the chair very appealing to children encouraging them to think of the chair as a toy rather than a rehabilitation device. The chair can be positioned either in the sitting or lying position to suit the child's positioning needs. It includes a wide range of accessories as standard, including; head support, back support, chest strap, side supports, pommel, arm rests, footrests and activity tray.

Features

- Height and width adjustable head support
- Width adjustable side pads support the chest and pelvis
- Adjustable chest and pelvic straps
- Depth adjustable seat allows for growth and change of posture
- Adjustable angle back support
- Removable abductor
- Footrests can be independently adjusted in height and angle
- When the backrest is completely reclined and the seat angle and footrest are adjusted the child can be comfortably positioned in the lying position
- Armrests are angle adjustable

Specifications	Small	Large
Seat Width	300mm	350mm
Seat Depth	100 - 240mm	180 - 320mm
Seat to footplate	200 - 290mm	210 - 350mm
Seat to top of armrest	130 - 230mm	170 - 350mm
Armrest to floor	590 - 670mm	670 - 860mm
Backrest Recline	0 - 90°	0 - 90°

09 117 4440 Small
09 117 4457 Large

Maximum user weight



2 Elephant Positioning Chair

The Elephant Positioning Chair is simple, functional and colourful with an attractive child friendly wood design. Adjustable side pads help to correct postural problems and the chair can be very useful for orthopaedic patients. The safety vest is equipped with an innovative "hold & pull" system which enables the carer to secure the child in the chair quickly and easily.

- Angle adjustable back support pad
- Adjustable side pads support the chest and pelvis
- "Hold & Pull" vest
- Adjustable and removable pommel
- Height adjustable foot rest with feet stabilising straps
- Optional adjustable headrest and activity tray available as accessories

09 142 3623 Small
09 142 3631 Medium
09 142 3649 Large

Accessories

Tray Small 09 142 3664 Medium 09 142 3672 Large 09 142 3698
Adjustable Headrest 09 142 3706 09 142 3714 09 142 3722

Specifications	Small	Medium	Large
Seat Width	150 - 270mm	220 - 330mm	250 - 370mm
Seat Depth	130 - 310mm	180 - 380mm	300 - 450mm
Seat to footplate	170 - 340mm	230 - 440mm	290 - 570mm
Footprint (Width x Length)	490 x 720mm	530 x 880mm	590 x 1160mm
Total Height	810mm	930mm	1200mm
Maximum Weight	30 kg 4 1/2 st	45 kg 7 st	75 kg 11 3/4 st

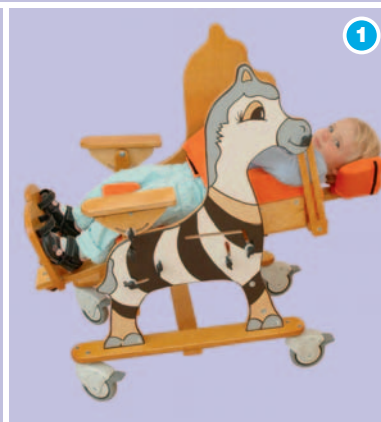
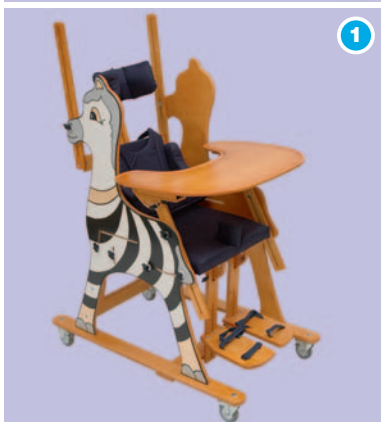

PICTURED WITH ADJUSTABLE HEADREST AND TRAY



1 The Wombat Functional Activity Chair

The Wombat is a Functional Activity Chair designed especially for children with disabilities. It is available in three sizes and is suitable for children from the age of one through to small adults. It provides outstanding levels of comfort and functionality, combined with exceptional design.

The Wombat has the following features:

- Tilt in space
- Back recline and prone angle
- Adjustable seat depth
- Adjustable back height
- Height and angle adjustable footrest

The Wombat has a fast height adjustment that is accomplished with either a gas spring or power option. Both chairs are available in four cover colours: Red, Blue, Green and Yellow for Small and Medium sizes. For Large, Black and Grey upholstery is available only. The chair is made from powder painted steel, ABS plastic and flameproof foam.

Wombat with Gas Spring

AA75370SB	Small	Blue
AA75370SF	Small	Red
AA75370SG	Small	Green
AA75370SI	Small	Yellow
AA75370MB	Medium	Blue
AA75370MF	Medium	Red
AA75370MG	Medium	Green
AA75370MI	Medium	Yellow
AA75370L	Large	

Wombat with Power

AA75371SB	Small	Blue
AA75371SF	Small	Red
AA75371SG	Small	Green
AA75371SI	Small	Yellow
AA75371MB	Medium	Blue
AA75371MF	Medium	Red
AA75371MG	Medium	Green
AA75371MI	Medium	Yellow
AA75371LB	Large	

Accessories

A range of accessories is available to extend and support the uses of the Wombat Chair (please note the tray can only be used in conjunction with the armrests).

AA7537001S	Abduction Block - Small
AA7537001M	Abduction Block - Medium
AA7537001L	Abduction Block - Large
AA7537002	Armrest Set - one size fits all
AA7537003	Tray - one size fits all
AA7537004S	Hip Support Set - Small
AA7537004M	Hip Support Set - Medium
09 116 6701	Hip Support Set - Large
AA7537005B	Head Support - one size fits all
AA7537006	Lift Handles - one size fits all
AA7537007	Swing Away Knee Supports - one size fits all
AA7537008S	Vest - Small
AA7537008M	Vest - Medium
AA7537008L	Vest - Large



The Wombat Functional Activity Chair - Specifications			
	Wombat Small	Wombat Medium	Wombat Large
Seat Depth	160-290mm	230-360mm	300-480mm
Seat Width	210-300mm	280-370mm	350-440mm
Back Height	280-340mm	310-380mm	390-500mm
Back Angle	-20° to 20°	-20° to 20°	-20° to 20°
Seat Angle	-20° to 15°	-20° to 15°	-22° to 10°
Frame Length	600mm	600mm	720mm
Frame Width	550mm	550mm	600mm
Seat Height	340-690mm	340-690mm	380-680mm
Weight	15.5kg	15.5kg	22kg
Maximum User Weight	45kg	45kg	70kg

DELIVERY
Delivery is approximately 4 to 6 weeks. Please contact Customer Services for more information.



1 Strato Classroom Chair

During school years, most children are likely to spend around 15,000 hours sitting down so encouraging good sitting posture from an early age is vital. It's the key to skeletal and muscular development, boosts concentration and gives children more confidence where they often need it most – in the classroom.

Strato is an innovative classroom chair designed for children and young people from 2 years to 19 years who are able to get in and out of their chair independently but require minimal to moderate postural support while seated. The chair is fully adjustable to suit the child and varying desks and tables. The seat lumbar prompt, armrests and footrests all have a wide range of adjustment without the need for tools. It also has an easy to read adjustment indicator to record user settings.

The Strato has been designed with a slimline footprint to ensure it slides under desks and tables saving space both in the classroom and at home.

Accessories

- Height, width and angle adjustable armrests accommodate each child's needs
- 4 point dynamic pelvic strap provides additional control of the pelvis without compromising hip flexion
- Height adjustable footrest provides even distribution and support for the feet
- Personal pocket for storing small items
- Handy hook for hanging personal items

09 120 4163	X-Small
09 120 4171	Small,
09 120 4189	Medium
09 120 4197	Large
09 120 4205	X-Large



DELIVERY
Delivery is approximately 4 to 6 weeks. Please contact Customer Services for more information.

Chair Specifications					
Size	X-Small	Small	Medium	Large	X-Large
Seat Depth	220mm	260mm	300mm	350mm	400mm
Seat Width	250mm	290mm	370mm	450mm	450mm
Seat Height	270-400mm	270-400mm	410-550mm	410-550mm	490-660mm
Seat Angle	0-15°	0-15°	0-15°	0-15°	0-15°
Armrest Width	240-300mm	300-360mm	370-470mm	440-550mm	440-550mm
Armrest Height	120-160mm	120-160mm	170-230mm	170-230mm	170-230mm
Armrest Angle	+12 to -12°	+12 to -12°	+12 to -12°	+12 to -12°	+12 to -12°
Seat to Footrest	180-280mm	180-280mm	270-350mm	330-420mm	400-500mm
Overall Seat Height	625mm	725mm	850mm	1000mm	1100mm
Footprint (Width x Length)	400x490mm	400x490mm	400x490mm	550x650mm	670x660mm
Max User Weight	40kg	40kg	80kg	80kg	90kg
Shipping Weight	13kg	13.5kg	21.5kg	22kg	23kg



BeSafe Car Seats

The BeSafe range of child car seats combine stylish design with comfort and unrivalled levels of safety testing. The seats are thoroughly crash tested, with accessories mounted on the seat, in accordance with ECE 4403.

1 BeSafe iZi Kid Car Seat

BeSafe iZi Kid is a Group 0/1 rear facing car seat and is suitable for children from birth to approximately four years of age. It is easy to install properly reducing the risk of incorrect fitting. The seat benefits from an integrated safety foot (patented), which means the seat is capable of absorbing enormous stress. The side protection is made of a patented mix of seven different energy-absorbing soft materials and protects the child's head, neck and internal organs.

The patented integrated belt-tightener, safely tightens the belt around the seat and the shoulder belt height can be easily adjusted using a simple handle. The seat benefits from a tilt-in-space function allowing five different sleeping and sitting positions and is constructed with ventilation slits in the back.

Colour may vary from catalogue image.

The seat is supplied complete with adjustable side supports,ommel, 5 point vest harness and headrest.

09 117 5181

2 BeSafe iZi Comfort Car Seat

The iZi Comfort Car Seat is a Group 1 forward facing car seat suitable for children aged 9 months to 4 years. The seat is fastened in from the front and all clips for the car's safety belt are smooth and operable from the front. The unique iZi-Tension-Plus System allows the car's safety belt to be tightened after fastening over the child seat, without strenuous effort.

The core of the seat is a break resistant plastic covered with an extremely strong 40mm thick upholstered polypropylene foam cover. Polypropylene is soft and absorbs impact energy helping to provide maximum side impact protecting the vulnerable head and pelvis areas. The shoulder belt height can be easily adjusted and the side belts clip comfortably on the left and right sides.

Colour may vary from catalogue image.

The seat is supplied complete with adjustable side supports,ommel, 5 point vest harness and headrest.

09 117 5199

3 Optional Wedge Cushion

Not Illustrated

This optional wedge cushion can be placed under the BeSafe Car Seats to achieve increased tilt.

09 117 8797



Specifications	iZi Kid	iZi Comfort
Seat Angle Interval	25°, 28°, 31°, 34°, 37°	18°, 22°, 25°, 30°
Wedge Cushion Angle	13°	13°
Seat and Wedge Combined	38°, 41°, 44°, 50°	31°, 35°, 38°, 43°
Back Height (seat cushion to top of back)	560mm	560mm
Shoulder Height (seat cushion to shoulder belt)	300-340-380mm	300-340-380mm
Seat Depth	310mm	310mm
Seat Width (back of seat)	240mm	240mm
Seat Width (front of seat)	300mm	300mm
Width between Side Supports	210mm	210mm
Approved Weight Class	0-18kg	9-18kg

1 BeSafe iZi Up Car Seat

The BeSafe iZi Up car seat is suitable for children aged 5 to 12 years (up to 135cm tall approximately) and is especially helpful for keeping children with special needs secure while travelling. This modern car seat has a handy swivel base addition which makes it extremely easy for parents to get their child in and out of the car seat, reducing manual handling risks.

The seat has been tested with adjustable side wings, pommel, adjustable headrest, vest, crotch strap, turntable and extra thigh support. All tested in accordance with ECE4404. The seat is supplied with a 5 point seat belt to hold your child securely and the option of a vest retainer to keep more active children safely in their car seat.

The optional turntable allows you to turn the seat out towards the car door and put the user in the seat, before turning it in again. You can hear a click when the turntable has locked in the direction of travel. It may be necessary for larger users to have the back supported while the seat is turned.

Both the angle and height of the back can be adjusted. The back angle can be adjusted by around 15 degrees by the lever at the side of the seat. The back returns automatically to the upright position when the child is removed from the seat.

The iZi Up car seat is also very lightweight and weighs just 8kg, making it even easier for the seat to be moved between cars or from the house to the car.

Standard features for BeSafe iZi Up:

- Crash tested with all accessories
- Special headrest, offering variable support
- Extra thigh support
- Side wings, adjustable in breadth and height
- Pommel
- Soft seat unit
- Soft back padding
- Adjustable seat depth and back height (the seat depth increases when the back height is adjusted)
- Adjustable back angle
- Ready for fitting turntable
- Ready for fitting vest
- Ready for crotch strap

09 118 4563 iZi Up Car Seat Charcoal Grey

108754 iZi Up Car Seat Green

Accessories

- 09 118 7624** Turntable
- 09 118 7640** Crotch Strap
- 09 119 1501** Vest Retainer Small
- 09 119 1519** Vest Retainer Medium
- 09 119 1527** Vest Retainer Large



AVAILABLE SEPARATELY



HEIGHT AND ANGLE OF BACK CAN BE ADJUSTED



TURNTABLE REDUCES MOVING & HANDLING RISKS



VEST RETAINER AVAILABLE



OPTIONAL CROTCH STRAPS



HEADREST PROVIDES OPTIMUM SUPPORT

Specifications

Seat Recline Range:	0-15°
Back Height (from seat cushion to top of back):	560-740mm
Seat Depth:	270-360mm
Seat Width (measured at the back of the seat):	300mm
Seat Width (measured at the front of the seat):	350mm
Max. Width (between side wings):	250-310mm
Approved Weight:	15-36kg
Weight:	8kg

1

Tumble Forms 2™
With Anti-Microbial Protection

Sammons
Preston



MEDIUM FEEDER SEAT POSITIONER FITS CHILDREN UP TO 1220MM (48")

DELUXE FOOT SITTER INCLUDES FEEDER SEAT AND WEDGE

BEST SELLER

1

Tumble Forms 2™ Deluxe Floor Sitter

The Deluxe Floor Sitter is a combination of the Feeder Seat Positioner (item 2) and the Floor Sitter Wedge (item 3). The Floor Sitter can be used for any short term activity in the home, clinic or school as an alternative to a wheelchair or stander. It allows good basic positioning without complicated adjustments.

Features

- Shoulder harness slots allow 100mm (4") of vertical adjustment of the shoulder straps to accommodate children of different heights
- Contoured interior has a 90° seat to back relationship to provide posturally correct seating
- A 45° Hip Strap and quick release H-Belt help maintain child's position
- Seamless coverings are washable, odour, urine and stain resistant and non-toxic

4542BB	Small	Blue
4542BR	Small	Red
4542BP	Small	Purple
4542BT	Small	Teal
4542AB	Medium	Blue
4542AR	Medium	Red
4542AP	Medium	Purple
4542AT	Medium	Teal
4542DB	Large	Blue
4542DR	Large	Red
4542DP	Large	Purple
4542DT	Large	Teal
4542EB	X-Large	Blue
4542ER	X-Large	Red
4542EP	X-Large	Purple
4542ET	X-Large	Teal

Spare straps are available for all sizes of Deluxe Floor Sitter and Feeder Seat.



2

Tumble Forms 2™ Feeder Seat Sammons Preston

The Feeder Seat is available to buy separately. It can be used with other Feeder Seat System accessories (such as The Mobile Base).

2795NB	Small	Blue
2795NR	Small	Red
2795NP	Small	Purple
2795NT	Small	Teal
2795MB	Medium	Blue
2795MR	Medium	Red
2795MP	Medium	Purple
2795MT	Medium	Teal
2795XB	Large	Blue
2795XR	Large	Red
2795XP	Large	Purple
2795XT	Large	Teal
2795YB	X-Large	Blue
2795YR	X-Large	Red
2795YP	X-Large	Purple
2795YT	X-Large	Teal



2

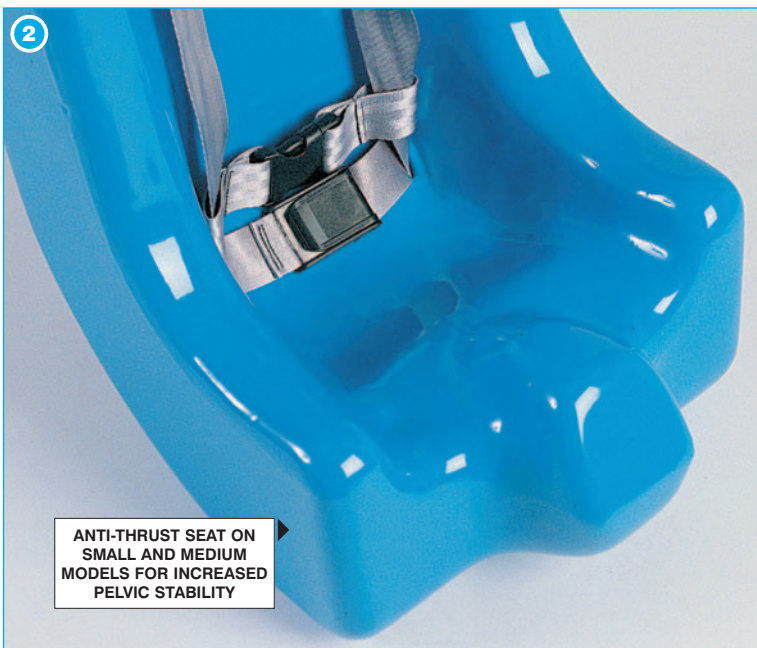

ANTI-THRUST SEAT ON SMALL AND MEDIUM MODELS FOR INCREASED PELVIC STABILITY

3

Tumble Forms 2™ Sitter Wedge Sammons Preston

The Floor Sitter Wedge is available to buy separately. It can be used to position the Feeder Seat Positioner in an upright or reclined position suitable for the child's activity. A Velcro hook and loop system holds the seat securely, allowing instant adjustability.

Fits Small, Medium and Large Feeder Seats. 400 x 560 x 300mm

4542WB	Blue
4542WR	Red
4542WP	Purple
4542WT	Teal

Fits X-Large Feeder Seat. 711 x 724 x 482mm

4542YB	Blue
4542YR	Red
4542YP	Purple
4542YT	Teal

Feeder Seat Sizing Chart

Dimension	Small	Medium	Large	X-Large
Overall Height	530mm (21")	685mm (27")	860mm (34")	1040mm (41")
Outside Width	265mm (10½")	355mm (14")	430mm (17")	530mm (21")
Inside Depth	200mm (8")	240mm (9½")	330mm (13¼")	420mm (16½")
Inner Height	460mm (18")	585mm (23")	730mm (29")	890mm (35")
Inner Width	187mm (7¼")	228mm (9")	317mm (12½")	380mm (15")
Child's Height	Up to 910mm(36")	Up to 1220mm(48")	Up to 1500mm(60")	Up to 1830mm(72")

1 Tumble Forms 2™ Feeder Seat Cozzee Cover

Sammons Preston

Made of soft, breathable fabric that will reduce sweating during times of heat and high humidity. It adds extra comfort to the Feeder Seat (or Deluxe Floor Sitter) and absorbs moisture. It attaches and removes easily and quickly with Velcro hook and loop fasteners. The Cozzee Cover is machine washable and can be tumble dried.

- 2785S Small
- 2785M Medium
- 2785L Large
- 2785XL X-Large



2 Tumble Forms 2™ Tray for Feeder Seat

Sammons Preston

Offers a flexible work surface for the Feeder Seat (or Deluxe Floor Sitter). The tray is adjustable in both angle and height. It features a non-slip work surface and rubber feet to prevent it from slipping. One size fits all. Work surface measures 580mm (23") square. It adjusts in height from 355 to 510mm (14 to 20").

Small-Large	X-Large	
2795T	-	Blue
09 117 8805	09 117 8847	Red
09 117 8813	09 117 8854	Purple
09 117 8821	09 117 8862	Teal



3 Tumble Forms 2™ Mobile Floor Sitter

Sammons Preston

Allows the carer to move or transport a child without repositioning. Ideal for children with poor mobility but can still mobilise and build lower extremity strength by moving themselves around. The Mobile Floor Sitter includes both the Feeder Seat and the Mobile Base.

- 4444M Medium
- 4542M Large
- 4542P X-Large



4 Tumble Forms 2™ Mobile Base

Sammons Preston

The Mobile Base is available separately. The medium and large sizes are made of wood coated with Tumble Forms covering. The X-large size is made of steel tubing. All sizes have easy rolling locking rear castors.

- 4444MC Medium
- 4542N Large
- 4542S X-Large



5 Tumble Forms 2™ Feeder Seat Rover Stroller

Sammons Preston

Provides proper support and positioning for the adolescent. The stroller frame combined with the Feeder Seat is an all-terrain solution - large tyres allow transportation over uneven surfaces. Rear wheels fold for easy storage and transportation. Medium Feeder Seat fits children up to 1220mm (48"). Large Feeder Seat accommodates children up to 1500mm (60") tall and 330mm (13") wide at the hips. X-Large Feeder Seat fits adolescents up to 1830mm (72") and features front swivel wheels.

- 4585 Medium Feeder Seat Rover Stroller
- 4587 Large Feeder Seat Rover Stroller
- 4586 X-Large Feeder Seat Rover Stroller

The Rover Stroller Frame may be ordered separately.

- 4585M Rover Stroller Medium - frame only
- 4587F Rover Stroller Large - frame only
- 4586XL Rover Stroller X-Large - frame only
- Features front swivel wheels
- 458501 Tray for Medium Stroller only (Does not fit Large or X-Large)



SPARES
Spares are available for these products, making them suitable for refurbishment. For full spares listing, please see pages 1353 to 1360.



AVAILABLE WITH OR WITHOUT A TRAY AND FOOTREST

Carrie Seat Sizing Chart				
	User Height Range	Maximum User Weight	Sitting Thigh Hip Width	Depth
4641S Pre-School	760-970mm (30-38")	9-18kg (1½-2¾st)	150-200mm (6-8")	200-280mm (8-11")
4641M Elementary	970-1220mm (38-48")	14-27kg (2¼-4½st)	200-250mm (8-10")	250-330mm (10-13")
4641L Junior	1220-1470mm (48-58")	23-46kg (3½-7¼st)	250-330mm (10-13")	310-380mm (12-15")
4641SA Small Adult	1470-1730mm (58-68")	27-59kg (4¼-9¼st)	310-410mm (12-15")	360-460mm (14-18")

Tumble Forms 2[®]

With Anti-Microbial Protection

1 Tumble Forms 2™ Carrie Seat

Sammons
Preston

The Carrie Seat is an extremely versatile seat that solves the positioning problems of day to day living. It has unique moulded contours that provide superior positioning compared to seats with upholstered pads. The anti-thrust seat shape helps maintain the proper pelvic position. Available in four sizes, with or without a tray and footrest (which are also available separately). It fits into most standard chairs in the home, at school or in a clinical setting.

Features

- Shock absorbing foam
- Seamless Tumble Forms 2 coating, impervious to fluid and easy to clean
- Lightweight seat, easy to remove and position
- Height adjustable neck stabiliser and four point adjustable harness
- The seat to back angle articulates 20° to help adjust to the user's upper body muscle tone

Pre-School Size

- 4641S** Seat with Tray and Footrest
- 9114** Seat only
- 9114S** Footrest (with Bar) only
- 9114T** Tray (with Bar) only
- 924641** Restrap Kit (Harness and Straps)

Elementary Size

- 4641M** Seat with Tray and Footrest
- 9115** Seat only
- 9115S** Footrest (with Bar) only
- 9115T** Tray (with Bar) only
- 924642** Restrap Kit (Harness and Straps)

Junior size

- 4641L** Seat with Tray and Footrest
- 9116** Seat only
- 9116S** Footrest (with Bar) only
- 9116T** Tray (with Bar) only
- 924643** Restrap Kit (Harness and Straps)

Small Adult Size

- 4641SA** Seat with Tray and Footrest
- 9117** Seat only
- 9117S** Footrest (with Bar) only
- 9117T** Tray (with Bar) only
- 924644** Restrap Kit (Harness and Straps)

SPARES
Spares are available for these products, making them suitable for refurbishment. For full spares listing, please see pages 1353 to 1360.

Carrie Seat Sizing Chart				
Seat Dimensions	Pre-School 4641S	Elementary 4641M	Junior 4641L	Small Adult 4641SA
Inner seat height	510mm (22")	660mm (26")	762mm (30")	840mm (33")
Inner seat depth	205mm (8")	255mm (10")	330mm (13")	395mm (15½")
Inner seat width	205mm (8")	255mm (10")	305mm (12")	355mm (14")
Outside seat width	305mm (12")	360mm (14¼")	410mm (16¼")	470mm (18½")

Tumble Forms 2™

With Anti-Microbial Protection

1 Tumble Forms 2™ Carrie Activity Base

Sammons
Preston

Raises the height of the Carrie Seat so the child can interact with peers and perform many activities. Activity Base can only be used with the Pre-School and Elementary Carrie seats. Rear wheels make moving easy.

4641C

2 Tumble Forms 2™ Carrie Collar

Sammons
Preston

This hinged collar supports the jaw line and occipital region to help improve head control, neck flexion and midline positioning. Can be used by itself or used with other seating systems. Designed to fit the Elementary Size Carrie Seat System. Attaches in the front with a quick release hook and loop fastener. Fits a 356mm (14") neck circumference. **Note:** The Carrie Collar should not be used as a child restraint in transport.

2774C

3 Tumble Forms 2™ Carrie Cozzee Cover

Sammons
Preston

Soft, washable cover provides comfort and absorbs moisture.

4642S Pre-School Cozzee Cover

4642M Elementary Cozzee Cover

4642L Junior Cozzee Cover

4642SA Small Adult Cozzee Cover

4 Tumble Forms 2™ Carrie Rover Stroller

Sammons
Preston

Combines the Carrie Seat with a stroller base for maximum mobility indoors or out. The Carrie Seat is removable. The stroller base is also sold separately.

Features

- Full feature, removable Carrie Seat
- Adjustable Tray
- Adjustable Footrest
- Lightweight, Folding Stroller Base.

4642 Pre-School Carrie Rover Stroller

4643 Elementary Carrie Rover Stroller

4644 Junior Carrie Rover Stroller

4645 Small Adult Carrie Rover Stroller

5 Tumble Forms 2™ Carrie Stroller Base

Sammons
Preston

Features

- Front swivel castors for manoeuvrability
- Oversized pneumatic rear tyres for a smooth ride
- Pre-School/Elementary size folds to a compact 318 x 559 x 762mm (12½ x 22 x 30")
- Junior size folds to 318 x 610 x 762mm (12½ x 24 x 30")
- Small Adult Rover has larger wheels (305mm front wheels and 406mm rear wheels), a heavy duty base for all terrain travel and folds to 406 x 606 x 914mm (16 x 24 x 36")

4588 Pre-School/Elementary Stroller Base

4589 Junior Stroller Base

4591 Small Adult Stroller Base



SPARES
Spares are available for these products, making them suitable for refurbishment. For full spares listing, please see pages 1353 to 1360.

1

NEW
IMPROVED



1 Multi-Positioning Seat System

The Special Tomato Multi-Positioning Seat offers comfortable and proper positioning support virtually anywhere. The modular cushion seating surface allows for individualised adjustment and many years of growth. The seamless, latex free waterproof cushions are soft, yet durable and impermeable to fluids. They withstand cracking and clean easily with common disinfectants and household cleaners. Attachment straps can be used to attach the Special Tomato Multi-Positioning Seat to most standard chairs. A mobility base option is available (a tilt-in-space floor base). Thigh Depth Extension Seat Cushions allow for child growth. A five point adjustable belt system holds children comfortably in a proper seating position. The Hip flex adjustment on seat cushion provides up to 15° of flexion and 15° of extension without recline.

Internal Seat	Width	Depth
Small	228mm	203mm
Small Extended	254mm	254mm
Large	280mm	280mm
Large Extended	330mm	381mm

- Approximate user age range:
Small, 2 to 8 yrs, Large, 8 to 14 yrs
- Adjustable footrests: small, seat to footrest adjusts 152 to 330mm, large, seat to footrest adjusts 280 to 407mm
- Activity Tray angle adjustable up to 30° of tilt
- Mobile Floor Base: 10° to 25° range of tilt-in-space. Four castors (rear lockable) Seat to floor height 380mm small, 457mm large

Choose Your Configuration

A MPS Mobile Floor Kit

- Adjustable Seat & Back Cushions
- Seat Shell
- Adjustable Footrest
- Mobile Floor Base
- Standard Headrest

B Multi-Positioning Seat (MPS)

- Adjustable Seat & Back Cushions
- Seat Shell
- Adjustable Footrest
- Standard Headrest



5 YEAR WARRANTY

Multi-Positioning Seat System

Item No.	Description	Size
928800	MPS Mobile Floor Kit A	Small
928802	MPS Seat with Footrest B	Small
928805	Extended MPS Mobile Floor Kit A	Small
928807	Extended MPS Seat with Footrest B	Small
928811	MPS Mobile Floor Kit A	Large
928813	MPS Seat with Footrest B	Large
928816	Extended MPS Mobile Floor Kit A	Large
928818	Extended MPS Seat with Footrest B	Large
09 116 2841	Standard Headrest	
09 116 2858	Headrest with Laterals	

Seating System Sizing Information

	Small		Large	
	Standard Seat	Extended Seat	Standard Seat	Extended Seat
Special Tomato Seats	Standard Seat	Extended Seat	Standard Seat	Extended Seat
Target User Age	2-5 years	5-8 years	8-11 years	11-14 years
Maximum User Weight	36.3kg (5 ³ / ₄ st)	36.3kg (5 ³ / ₄ st)	68kg (10 ³ / ₄ st)	68kg (10 ³ / ₄ st)
Seat Weight	10kg	10kg	12kg	13kg
Seat & Floor Base Weight	18kg	19kg	20kg	21kg
Seat Width	229mm (9")	254mm (10")	305mm (12")	330mm (13")
Seat Depth	203mm (8")	254mm (10")	330mm (12")	381mm (15")
Seat to Footrest	152-406mm (6-16")	152-406mm (6-16")	203-457mm (8-18")	203-457mm (8-18")
Top of Back Cushion	381-483mm (15-19")	381-483mm (15-19")	432-533mm (17-21")	432-533mm (17-21")
Top of Head Cushion	559-686mm (22-27")	559-686mm (22-27")	610-737mm (24-29")	610-737mm (24-29")
Hip Flex Angle	-15° to +15°	-15° to +15°	-15° to +15°	-15° to +15°
Floor to Seat Height	381mm (15")	381mm (15")	457mm (18")	457mm (18")
Tray	610 x 432 x 51mm	610 x 432 x 51mm	610 x 432 x 51mm	610 x 432 x 51mm
MPS Seat Only	381 x 483 x 1067mm	381 x 483 x 1067mm	483 x 584 x 1194mm	483 x 584 x 1194mm
MPS Floor Kit	483 x 940 x 940mm	483 x 940 x 940mm	559 x 1041 x 1067mm	559 x 1041 x 1067mm



2 MPS Tray

A depth adjustable tray with a 60° tilt adjustment. The tray easily attaches to the back of the Mobile Floor Base for storage.

- 928803 Small
- 928814 Large

3 Extended Seat Cushion

As the child outgrows the standard cushion, simply purchase the extended cushion.

- 928808 Small
- 928819 Large

4 Mobile Floor Base

This mobile base for the MPS seat has built-in tray storage on the back. It has four swivel castors with rear locks, and a 10-25° range of tilt-in space.

- 928804 Small
- 928815 Large

5 Tomato Skins

An optional black cushion cover that custom-fits the Special Tomato MPS seat. Made of soft, durable fabric to absorb moisture and provide added comfort.

- 550746 Small
- 550747 Large





5 YEAR WARRANTY



1 Soft-Touch™ Sitters

These soft, supportive sitters provide a comfortable alternative type of seating. Made from a latex free seamless material, the Soft-Touch Sitters are peel and tear resistant, impermeable to fluids and withstand cracking. The soft, durable material is anti-microbial and cleans easily using household disinfectants. Available in five sizes, the Soft-Touch Sitters are suitable for very young children through to young adults. All sizes can be securely attached to standard chairs. The Soft-Touch Sitters are available in three options:

- As a sitter only
- A sitter with a tilt wedge
- A sitter with a mobile tilt wedge

All feature a soft contoured seat with an integral anti-thrust seating surface, contoured lateral and head supports, adjustable five point harness and attachment straps. The sitters with the tilt wedge and mobile tilt wedge are adjustable from upright to 25° of tilt. The mobile tilt wedge includes four swivel castors, the rear two of which can be locked.

Tan	Lilac (Harness colour)	
553376	09 118 6147	Sitter Size 1
553377	09 118 6154	Sitter Size 2
553378	09 118 6162	Sitter Size 3
553379	09 118 6170	Sitter Size 4
553380	09 118 6188	Sitter Size 5
553381	09 118 6196	Sitter with Tilt Wedge Size 1
553382	09 118 6220	Sitter with Tilt Wedge Size 2
553383	09 118 6238	Sitter with Tilt Wedge Size 3
553384	09 118 6261	Sitter with Tilt Wedge Size 4
553385	09 118 6279	Sitter with Tilt Wedge Size 5
553386		Optional Small Tilt Wedge Sizes 1-3
553387		Optional Large Tilt Wedge Sizes 4-5
553388	09 118 6311	Sitter with Mobile Tilt Wedge Size 1
553389	09 118 6337	Sitter with Mobile Tilt Wedge Size 2
553390	09 118 6345	Sitter with Mobile Tilt Wedge Size 3
553391	09 118 6360	Sitter with Mobile Tilt Wedge Size 4
553392	09 118 6386	Sitter with Mobile Tilt Wedge Size 5
553393		Optional Small Mobile Tilt Wedge Sizes 1-3
553394		Optional Large Mobile Tilt Wedge Sizes 4-5



5 YEAR WARRANTY

SITTER WITH TILT WEDGE KIT

Sitter Specifications					
	Size 1	Size 2	Size 3	Size 4	Size 5
User Weight	9-18kg	14-27kg	18-36kg	23-50kg	41-91kg
User Height	750-1000mm	875-1400mm	1000-1400mm	1250-1625mm	1350-1850mm
Age Range	1-3 years	3-6 years	6-9 years	9-14 years	13-adult
Inner Seat Depth	175mm	238mm	288mm	338mm	400mm
Inner Seat Width	200mm	250mm	300mm	350mm	400mm
Seat Back Height	525mm	650mm	725mm	875mm	975mm
Overall Seat Depth	300mm	350mm	400mm	475mm	525mm
Overall Seat Width	300mm	350mm	400mm	450mm	500mm
Overall Seat Height	625mm	725mm	850mm	1000mm	1100mm
Seat Weight	2.7kg	4.5kg	5.9kg	6.8kg	8.6kg

Base Specifications			
Small (Fits Sitter Sizes 1-3)		Large (Fits Sitter Sizes 4-5)	
Overall Width	400mm	Overall Width	525mm
Overall Depth	575mm	Overall Depth	800mm
Overall Height	325mm	Overall Height	575mm
Base Weight	7.3kg	Base Weight	10.9kg
Degree of Tilt	25°	Degree of Tilt	25°

1 Early Sitting System

The ESS is a dynamic and versatile early activity system for children from 2 years to 4 years. The system has a lightweight seat base which has a unique dynamic trunk support system that allows the child increased freedom to explore their environment and develop increased spatial awareness. The versatility of the design means it can be used for floor based activities or attached to a high chair for feeding or increased social interaction with family or peers. It can also be easily converted into a long sitter to enable extension, preventing hamstring tightening. With the attachment of the simple prone bar the product is transformed into a prone sitter which helps the pelvis into neutral alignment and assists in trunk extension to maximise function. This lightweight sitting solution is extremely portable and can be easily stored or transported for use in a wide range of environments such as home, pre-school or socially in places such as restaurants or at the cinema.

Early Sitting System

Includes Seat Base, Trunk Support, Pelvic Harness, Seat & Trunk Cushions and Chair Attachment Straps.

09 117 8318

Accessories

09 117 8326 Leg Support (includes Shell, Leg Cushion, Leg Support, Pommel and Positioning Strap)

09 117 8334 Activity Tray

09 117 8342 Abduction Pommel

09 117 8359 Flexion Roll

09 117 8367 Spacer Pads (pair)

09 117 8375 Prone Bar

All cushions are only available in one colour

2 Early Activity System

The EAS is a colourful set of flexible and versatile positional supports. It can be secured on to a hook and loop floor mat and used to deliver an effective early intervention programme for the infant in either the home or pre-school environments. The system comes with an easy to follow illustrated guide, which shows a range of best practice therapy activities. These can be used by the therapist to help develop key physical, sensory, cognitive and transitional developmental goals such as trunk control, head control, hand-eye coordination, spatial awareness, balance and strength. The Activity Development Programmes break tasks into manageable steps based on the individual's abilities and encourages progression through play.

Early Activity System

Includes Floor Mat, Sitting Support, Trunk Wedge, Head Support, 2 Positioning Straps, 2 Medium Rolls, 2 Small Rolls and Carrying Bag. The floor mat is machine washable and all other components are wipe clean.

09 117 8300





Soft-Touch™ Therapy Rolls and Wedges

These therapy rolls and wedges are very soft to the touch giving the maximum amount of comfort without sacrificing any durability. The latex free, seamless material makes the rolls and wedges peel and tear resistant and impermeable to fluids. The material also withstands cracking, includes an anti-microbial agent and cleans easily with common household disinfectant. The integrated Soft-Touch handle makes for easy handling and control. The stand-on-end design features a concave end that allows the rolls and wedges to be placed in a small area out of the way when not in use.

1 Special Tomato™ Soft-Touch™ Therapy Rolls

These rolls are designed for applications such as flexion and extension, balance, postural therapy and neuro-development activities. To provide a firm platform for therapeutic applications, there is a solid core on all rolls (except the 102mm diameter).

Chocolate	Blue	Plum	Diameter and Length
09 132 2841	553350	N/A	102 x 610mm (4 x 24")
553351	N/A	553851	152 x 610mm (6 x 24")
553352	N/A	N/A	203 x 610mm (8 x 24")
09 132 2858	553353	553853	203 x 914mm (8 x 36")
553354	N/A	N/A	254 x 914mm (10 x 36")
09 132 2866	553355	553855	305 x 914mm (12 x 36")
09 132 2874	553356	553856	305 x 1219mm (12 x 48")
09 132 2882	553357	553857	356 x 1219mm (14 x 48")
553358	N/A	553858	406 x 1219mm (16 x 48")
09 115 7791			76 x 203mm (3 x 8")

2 Special Tomato™ Soft-Touch™ Therapy Wedges

These wedges are ideal for applications such as adaptive positioning, balance and muscle tone control. They are recommended for fine and gross motor activities, along with dynamic movement patterns. Available in chocolate colour only.

Chocolate	Blue	Plum	Diameter and Length
09 132 2890	N/A	N/A	102 x 508 x 560mm 10°
09 132 2908	553364	553864	152 x 508 x 560mm 16°
553365	N/A	553865	203 x 508 x 560mm 20°
09 132 2916	N/A	553866	152 x 610 x 711mm 12°
553367	N/A	553867	203 x 610 x 711mm 16°
09 132 2924	553368	553868	254 x 508 x 560mm 26°
553369	N/A	553869	254 x 610 x 711mm 20°
553370	N/A	553870	305 x 610 x 711mm 24°



Tumble Forms 2[™]

With Anti-Microbial Protection



1 Tumble Forms 2[™] Rolls Sammons Preston

Adaptive shapes for rolling and rocking movements, for positioning and neuro-developmental training. Soft yet firm rolls have a solid core to prevent flattening at the bottom (except the 102mm diameter size).

	Length	Diameter
2794A	610mm (24")	102mm (4")
2794B	610mm (24")	152mm (6")
2794F	610mm (24")	203mm (8")
2794G	914mm (36")	203mm (8")
2794C	914mm (36")	254mm (10")
2794D	914mm (36")	305mm (12")
2794H	1219mm (48")	305mm (12")
2794E	1219mm (48")	356mm (14")
2794J	1219mm (48")	406mm (16")



2 Tumble Forms 2[™] Raised Rolls Sammons Preston

Offers the positioning options of conventional rolls with the stability of a wedge. Raised rolls provide a stable base for bolster sitting, side leaning or prone positioning. Smaller rolls can be used for knee or ankle flexion and cervical elongation. A hook and loop strip on the bottom of each roll holds it in place for active or static therapies.

	Length	Elevation	Width
2789A	457mm (18")	51mm (2")	102mm (4")
2789B	457mm (18")	76mm (3")	102mm (4")
2789C	610mm (24")	115mm (4 1/2")	152mm (6")
2789D	762mm (30")	152mm (6")	203mm (8")



3 Tumble Forms 2[™] Rolls Rack Sammons Preston

This attractive, 1680mm (66") long, wall mounted rack holds up to 12, 150mm (6") or 205mm (8") diameter rolls or six of the larger sizes.

2797



4 Tumble Forms 2[™] Therapist Starter Kits Sammons Preston

These specially selected assortments of rolls and wedges are ideal for gross motor activities such as rolling, tumbling, and walking up or downhill. They also provide comfortable positioning for reading or fine motor activities. Rolls are adaptive shapes for rolling and rocking movements and for positioning and neuro-developmental training.

Therapist Starter Kit Pack 1

- 1 raised roll 610 x 115 x 152mm (24 x 4 1/2 x 6")
- 1 roll 610 x 203mm (24 x 8")
- 1 wedge 152 x 508 x 559mm (6 x 20 x 22") 12.5° incline

556800

Therapist Starter Kit Pack 2

- 1 raised roll 762 x 152 x 203mm (30 x 6 x 8")
- 1 roll 914 x 254mm (36 x 10")
- 1 wedge 305 x 610 x 711mm (12 x 24 x 28") 22.5° incline

556801

Therapist Starter Kit Pack 3

- 1 raised roll 610 x 115 x 152mm (24 x 4 1/2 x 6")
- 1 roll 1219 x 406mm (48 x 16")
- 1 wedge 152 x 508 x 559mm (6 x 20 x 22") 12.5° incline
- 1 wedge 254 x 610 x 711mm (10 x 24 x 28") 20° incline

556802



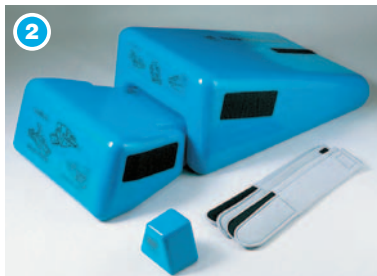

Tumble Forms 2[™]

With Anti-Microbial Protection

1 Tumble Forms 2[™] Deluxe Strap Wedges Sammons Preston

This wedge includes two wrap straps, which provide added flexibility in positioning the child properly. The movable straps support the child gently, yet firmly, when and where needed to ensure the most comfortable position.

	Height	Width	Length	Incline
2779A	102mm (4")	508mm (20")	559mm (22")	8°
2779B	152mm (6")	508mm (20")	559mm (22")	12.5°
2779C	203mm (8")	610mm (24")	711mm (28")	12.5°
2779D	254mm (10")	610mm (24")	711mm (28")	20°
2779E	305mm (12")	610mm (24")	711mm (28")	22.5°
928266	Replacement Hook and Loop Pad Strips			



2 Tumble Forms 2[™] Adolescent Thera-Wedge Sammons Preston

Provides dynamic therapy and proper positioning. Specially designed to meet the needs of adolescents and small adults. This system consists of two wedges contoured on one side and flat on the other. Use together to help break extensor patterns and relax clients into a flexion pattern. Provides proper prone and supine positioning, whether used alone or together. Complete system includes one double sided 430mm (17") contoured wedge with ankle drop off, one double sided 305mm (12") contoured wedge, two wrap straps and one abductor module.

2799A
Spares Available

- 922799** Small Thera Wedge Half - no straps
- 92279901** Large Thera Wedge Half - no straps
- 92829901** Hook and Loop Strap - 660mm (26") long
- 928299** Thera Wedge Strap - hook half



3 Tumble Forms 2[™] Slotted Wedges Sammons Preston

These durable wedges offer a variety of positioning options for children and adults. Used in conjunction with a supine mat, or bed positioning, the wedges help alignment of the hip, preventing rotation and providing abduction of lower extremities. They promote comfort and optimal positioning during treatment sessions and the leg troughs offer a natural, comfortable support to lower extremities. Available in four sizes. Latex free.

	Height	Width	Depth
09 115 7759 Small	229mm (9")	610mm (24")	356mm (14")
	Floor to slot 140mm (5 1/2")		

	Height	Width	Depth
09 115 7767 Medium	305mm (12")	635mm (25")	356mm (14")
	Floor to slot 165mm (6 1/2")		

	Height	Width	Depth
09 115 7775 Large	330mm (13")	660mm (26")	406mm (16")
	Floor to slot 178mm (7")		

	Height	Width	Depth
09 115 7783 X-Large	406mm (16")	737mm (29")	483mm (19")
	Floor to slot 216mm (8 1/2")		



SPARES
Spares are available for these products, making them suitable for refurbishment. For full spares listing, please see pages 1353 to 1360.

Tumble Forms 2[®]

With Anti-Microbial Protection

1 Tumble Forms 2™ Wedges Sammons Preston

Wedges are one of the most versatile therapy tools available. Ideal for gross motor activities such as rolling, tumbling, and walking on inclines. They also provide comfortable positioning for reading or fine motor activities. Can be used as an alternative to sitting when a child lacks head control, balance or trunk control.

Potential uses of wedges include

- Promoting weight bearing on upper extremities (such as shoulders, elbows and extended forearms)
- Facilitating head rising and controlled movement
- Promoting extension of hips and knees
- Facilitating rolling skills

	Height	Width	Length	Incline
2795A	102mm (4")	508mm (20")	559mm (22")	8°
2795B	152mm (6")	508mm (20")	559mm (22")	12.5°
2795C	203mm (8")	508mm (20")	559mm (22")	20°
2795J	254mm (10")	508mm (20")	559mm (22")	22.5°
2795D	152mm (6")	610mm (24")	711mm (28")	8°
2795E	203mm (8")	610mm (24")	711mm (28")	12.5°
2795F	254mm (10")	610mm (24")	711mm (28")	20°
2795L	305mm (12")	610mm (24")	711mm (28")	22.5°
4768B	Add-on Leg Abductor Wedge - 127mm (5") high attaches with hook and loop strip.			



1

2 Tumble Forms 2™ Biform Wedges Sammons Preston

Innovative wedges provide two wedge positions in one. Side walls provide lateral support while keeping child's arms flexed forward. Wedges can be nested together for more prone and supine positioning options. Hook and loop straps secure positioning. One side of the wedge is 50mm (2") deeper than the other side. Elevation measured from bottom of channel to top of side.

	Elevation	Base
2805A	100 or 150mm (4 or 6")	455 x 560mm (18 x 22")
2805B	200 or 250mm (8 or 10")	455 x 560mm (18 x 22")
2805C	150 or 200mm (6 or 8")	560 x 660mm (22 x 26")
2805D	250 or 300mm (10 or 12")	560 x 660mm (22 x 26")
922805	Replacement Strap for 2805A and 2805B	
922806	Replacement Strap for 2805C and 2805D	



1



2



SPARES
Spares are available for these products, making them suitable for refurbishment. For full spares listing, please see pages 1353 to 1360.



1

Tumble Forms 2™ With Anti-Microbial Protection

1 Tumble Forms 2™ Universal Side Lyer

Sammons
Preston

Minimises the time a therapist, teacher or aide needs to monitor the positioning of neurologically impaired children. While decreasing abnormal extension, it provides a supportive learning environment enabling the child to focus on activities in front of them. Side positioning decreases abnormal extension, maintains shoulder protraction and allows the arms to be placed in midline position.

Uses Include

- Improved head control
- Improving forearm, hand function and hand-eye coordination
- Postural drainage

The 1065 x 585mm base is angled so that gravity helps position the child. Two soft easy to use straps permit infinite adjustment. Two accessory block modules 75 x 125 x 280mm (3 x 5 x 11") can be used as a headrest or for leg abduction (not included). The seamless soft upholstery is resistant to urine and is easy to clean. Measures 355mm (14") deep. Backrest 230mm (9") high.

2798 Universal Side Lyer

2796A Optional Block Modules

928254 Spare Side Lyer Strap



2

2 Tumble Forms 2™ Tadpole Paediatric Positioner

Sammons
Preston

Designed specifically for early intervention programs. Infants from birth to age three with cerebral palsy, motor delays or other motor dysfunctions benefit from this multi-use unit as an essential part of an effective therapy program. Ideal for clinic or home-based use. The latex-free Tadpole positioner includes a carrying bag to conveniently store all modules: 860 x 480mm (34 x 19") Base, Half Roll, Wedge, and Tray with Mirror for creative positioning. The therapist can create passive, active and developmental exercises for the user.

Uses Include

- Positioning (side lying, prone, supine or sitting)
- Weight bearing to particular body areas (e.g. pelvis, arms)
- Vestibular activity
- Postural drainage

The soft Tumble Forms 2 covering is easy to clean, non-toxic and latex free.

The Tadpole offers a range of positioning options:

- **Prone:** With the half roll and two lateral supports, the Tadpole Positioner facilitates active body extension, head flexion, chest elevation and forward propping of arms for midline hand touching. The mirrored unit encourages the child's curiosity. The log roll can be placed under the base for vestibular activities.
- **Seated:** The base and wedge modules can be used together for long leg or log roll sitting. Either side of wedge may be used depending on the desired degree of upright or reclined position. The attached tray provides additional support and a surface area for activities.
- **Side-lying:** The log roll can be attached to base for side-lying to facilitate control of lateral head and trunk movements. The base can be propped up to position the child for improved respiration.

4772T Full Kit

Spares and Accessories Available

4772TH Half Roll

4772TW Wedge

4772TM Tray With Mirror

924772 Base



2



2



2



SPARES

Spares are available for these products, making them suitable for refurbishment. For full spares listing, please see pages 1353 to 1360.

Tumble Forms 2[™] With Anti-Microbial Protection

1 Tumble Forms 2[™] Universal Grasshopper System Sammons Preston

This modular system can be used to position children and adults. The seventeen different positioning modules allow the therapist to creatively position the child in an infinite number of ways.

Uses Include

- Vestibular activities
- Prone or supine positioning
- Side lying positioning
- Long leg and roll sitting positioning

The mobile base allows easy transportation of the child, while maintaining adaptive support. It has locking castors that are 63mm (2½") in diameter. With the mounting plates the Grasshopper is 76mm (3") off the floor. The soft covering is easy to clean and is non-toxic.

4775 Complete System

Spares and Accessories Available

924781	Short Rectangle	140 x 280 x 75mm (5½ x 11 x 3")
924774	Log	1220mm (48")
924775	Small Wedge	150mm (6") high
924777	Trapezoid	130 x 460mm (5 x 18")
924776	Large Wedge	200mm (8") high
924773	Base	1420mm (56") long
928284	Buckle Strap	1778mm (70") long
928294	Restraint Pad W/Pad (Sidelyer Strap)	1525mm (60")
928295	Restraint Pad - only	
928296	Hook and Loop Restraint Strap	1525mm (60")
928297	Tab Strap	305mm (12")
928298	Pull Strap	
928300	Rear Castor	
928301	Front Castor with Brake	
9101	Accessory Wedge	280 x 254 x 64mm (11 x 10 x 2½")
9102	Quarter Roll	
9106	Wrap Straps	
4768B	Abductor Wedge	127mm (5") high



2 Tumble Forms 2[™] Deluxe Square Module Seating System Sammons Preston

Supports and positions children with neurological impairments. The seat comes complete with two long rectangles, two short rectangles and two triangles, as well as one ring and one disk. Base measures: 508 x 508 x 279mm (20 x 20 x 11").

2797 Deluxe Square Module Seating System



SPARES
Spares are available for these products, making them suitable for refurbishment. For full spares listing, please see pages 1353 to 1360.



1 Diana

This unit is used extensively with the care of the terminally sick child. Professionals, parents and especially the children respond to this very simple lightweight and aesthetically pleasing unit.

It has been especially designed for night positioning for abduction and adduction. The unit is placed as close to the crutch as possible to reduce hip rotation.

Reduced night tone can be observed, therefore it copes with strong extensor spasm and the unit acts as an inhibitor.

Good body symmetry is achieved just by using this unit.

Length 483mm (19"). Width 610mm (24"). Depth 229mm (5").

Weight 1.5kg.

AA75411

2 Jeffery

For night positioning, this unit copes with clients having reduced activity, eg. muscular dystrophy. It gives effective abduction and adduction. A corrective midline position is achieved and reduction of the lumbar curve has been observed. The unit is positioned as close to the crutch as possible to reduce hip rotation.

Length 686mm (27"). Width 610mm (24"). Depth 254mm (10").

Weight 2.5kg.

AA75412

3 Gustav

The Gustav unit is designed for a range of conditions.

It is extremely good for prone positioning as side rotation and slipping down are eliminated due to the unique support it provides.

Visible reduction of high tone and the reduction of muscle spasm are soon observed. Whilst prone, good shoulder rotation can be achieved. Supine and side lying are also possible,

as is secure, comfortable postural drainage.

Length 965mm (38"). Width 584mm (23"). Depth 635mm (25").

Weight 5kg.

AA75409

4 Timor

Designed for postural drainage. When placed face downwards, a child is held securely and comfortably, which is an important factor when children need long and frequent treatment sessions. When placed face up, it creates an effective pillow that gives good trunk, neck and head support. This application caters for patients with respiratory problems. It is also useful for kyphosis and scoliosis.

Length 483mm (19"). Width 571mm (22¹/₂"). Depth 356mm (14").

Weight 1.8kg.

AA75410

1 Versa Form™ Positioning Pillows (White)

Versa Form pillows provide customised, semi-permanent positioning, when standard positioners won't do or when temporary positioning is needed. Pillows are filled with small polystyrene beads which mould to the individual's body shape when air is extracted. When the valve is released, allowing air into the pillow, Versa Form regains its flexibility and is ready to be shaped again. Forms a firm support for all parts of the body uniformly, reducing the risk of pressure points. Can be used to accommodate structural deformities and help control posture. Retain their shape for up to one month. They can be used for a wheelchair seat and back positioning, in bed positioning and extremity positioning. Easily shaped and reshaped in seconds, the density and firmness can be effortlessly moulded.

The durable, polyvinyl shell is easy to clean and disinfect for multiple client use. **Vacuum pump sold separately below.**

2823	410 x 510mm (16 x 20")
2820	560 x 305mm (22 x 12")
2821	560 x 660mm (22 x 26")
2822	560 x 860mm (22 x 34")
2805	810 x 1015mm (32 x 40") - Half Mattress
2820V	Spare Valve



2 Versa Form™ Plus Positioning Pillows (Blue)

The Versa Form Plus offers all the advantages of the Versa Form in a more durable package. The high grade vinyl used in the Versa Form Plus allows it to retain its shape for up to three times longer than the standard Versa Form. It is also even easier to clean.

2833	410 x 510mm (16 x 20")
2830	560 x 305mm (22 x 12")
2831	560 x 660mm (22 x 26")
2832	560 x 860mm (22 x 34")
2834	810 x 1015mm (32 x 40") - Half Mattress
2820V	Spare Valve

3 Versa Form™ Pillow Covers

The covers provide extra comfort with either a terry cloth or sheepskin cover.

2830CT	560 x 305mm (22 x 12")	Terrycloth
2831CT	560 x 660mm (22 x 26")	Terrycloth
2832CT	560 x 860mm (22 x 34")	Terrycloth
2833CT	410 x 510mm (16 x 20")	Terrycloth
2834CT	810 x 1015mm (32 x 40")	Terrycloth
2830S	560 x 305mm (22 x 12")	Sheepskin
2831S	560 x 660mm (22 x 26")	Sheepskin
2832S	560 x 860mm (22 x 34")	Sheepskin
2833S	410 x 510mm (16 x 20")	Sheepskin
2834S	810 x 1015mm (32 x 40")	Sheepskin

4 Versa Form™ Vacuum Pump

Single handed operation allows the user to form the pillow at various points while removing the air.

2825



SPARES
Spares are available for these products, making them suitable for refurbishment. For full spares listing, please see pages 1353 to 1360.

Tumble Forms 2® Three-In-One TriStander® Sammons Preston

The TriStander positioner does the job of three conventional standers. Its unique design allows prone, supine and vertical standing. A floor operated pneumatic tilt mechanism makes it easy to adjust the stander from 15° to 90°. The wide range of adjustability in the TriStander allows it to grow with the child. The adjustable module cushions can be mounted on either size frame to accommodate the unique positioning needs of the client. Each cushion is shaped to position the child securely and they are also easy to wash and disinfect. Latex free.

Tumble Forms 2®
With Anti-Microbial Protection

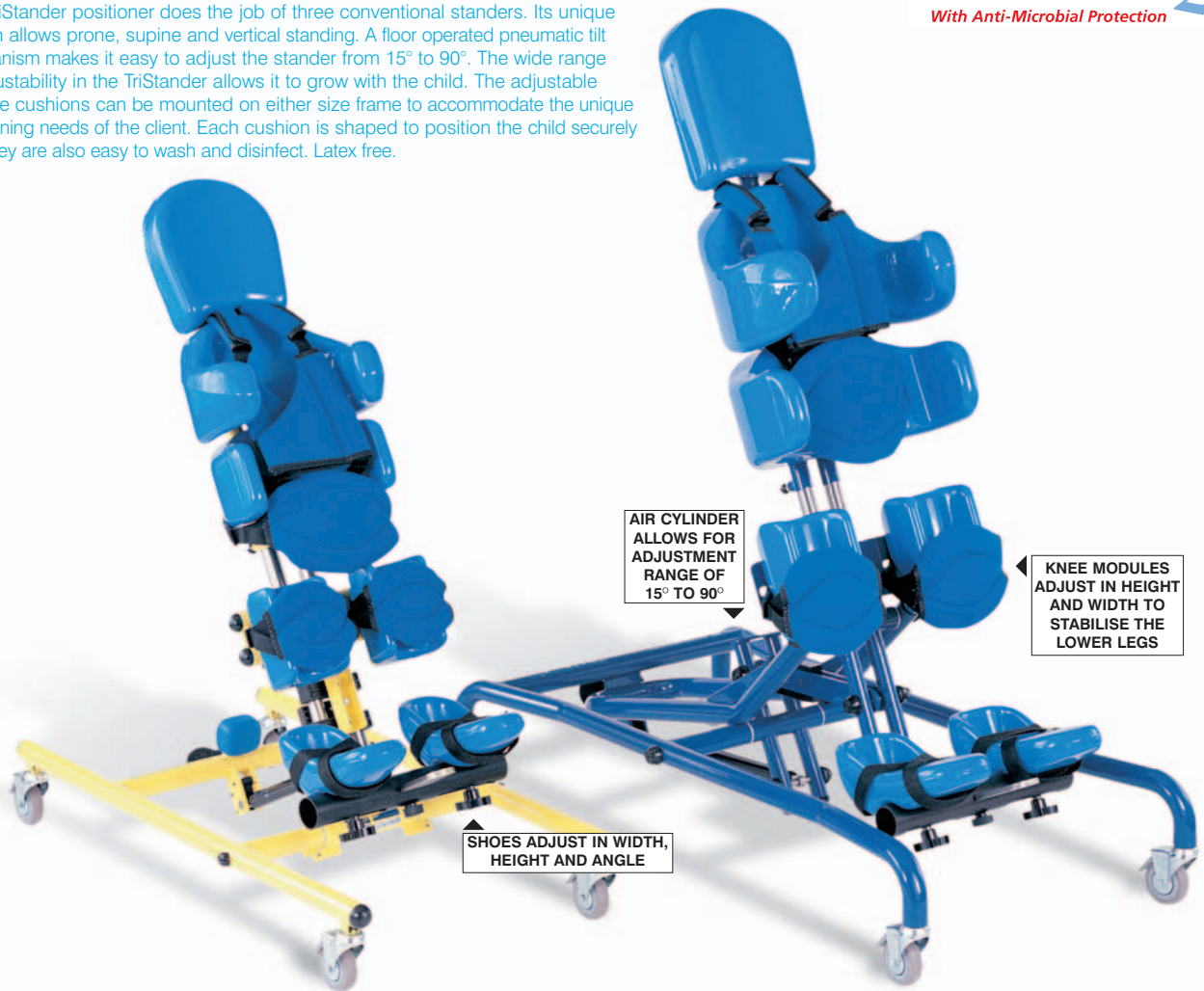

TriStander Features

- Adjustable, soft, cushioned pads
- Pads are seamless, impervious to body fluids and wipe clean
- Module cushions are interchangeable
- 75mm (3") double locking castors prevent roll and swivel

Available in Two Sizes

The TriStander 45 (yellow frame) accommodates children from 810mm (32") to 1140mm (45") and the TriStander 58 (blue frame) accommodates children from 1090mm (43") to 1470mm (58") in height.

The TriStander Includes

- TriStander frame
- Hip support
- Knee support
- Shoes with bar
- Headrest
- Trunk support

- 4525S** TriStander 45 (Yellow Frame)
- 4530S** TriStander 58 (Blue Frame)
- 4526S** TriStander 45 with Activity Tray
- 4529S** TriStander 58 with Activity Tray

TriStander 45

Maximum user weight **32 kg** **5 st**

TriStander 58

Maximum user weight **68 kg** **10 1/2 st**

DELIVERY
Delivery is approximately 6 weeks. Please contact Customer Services for more information.

Tumble Forms 2®
With Anti-Microbial Protection



HEADREST



SHOES WITH BAR



KNEE SUPPORT



PUSH HANDLE



ADJUSTABLE TRUNK SUPPORT



HEAD SUPPORT WITH LATERALS



HIP SUPPORT



TRUNK SUPPORT

Tumble Forms 2® TriStander® Accessories

Sammons Preston

The module cushions and frame included with each model are also available separately. They are sized larger for the TriStander 58 and smaller for the TriStander 45. The adjustable module cushions can be mounted on either size frame to accommodate the unique positioning needs of the child. Each cushion is shaped to position the child securely. They are also easy to wash and disinfect. Latex Free.

All of the components, including the frame can be ordered separately as accessories.

TriStander 45 Accessories

4525F	Frame only	545 x 965mm
4525H	Headrest	228 x 247mm
4525K	Standard Trunk Support	215 x 140mm (inside)
4526K	Medium Trunk Support	254 x 165mm (inside)
4525P	Hip Support	215 x 101mm (inside)
4525N	Knee Support (pair)	76 x 57mm (inside)
4525E	Shoes with Bar	216 x 70mm (inside)
4525T	Activity Tray	660 x 660mm
924526	Head Support with Laterals	228 x 241mm (76mm laterals)
924527	Adjustable Trunk Support	192 x 152 to 190mm (inside)
924528	Push Handle	78 x 254mm
924525R	Complete Set of Straps and Pads	

TriStander 58 Accessories

4527F	Frame only	584 x 1194mm
4527H	Headrest	228 x 266mm
4527K	Standard Trunk Support	292 x 152mm (inside)
4526K	Medium Trunk Support	254 x 165mm (inside)
4527P	Hip Support	305 x 152mm (inside)
4527N	Knee Support (pair)	101 x 57mm (inside)
4527E	Shoes with Bar	261 x 89mm (inside)
4527T	Activity Tray	737 x 737mm
924526	Head Support with Laterals	228 x 241mm (76mm laterals)
924527	Adjustable Trunk Support	192 x 152 to 190mm (inside)
924528	Push Handle	78 x 254mm
924530R	Complete set of Straps and Pads	



SPARES

Spares are available for these products, making them suitable for refurbishment. For full spares listing, please see pages 1353 to 1360.

1



1 Marvel Free Stander

Simple and effective, the Marvel vertical stander provides vertical alignment and upright support. It is easy to assemble, adjust and reposition. The Marvel offers four points of support at the foot, knee, pelvic and trunk level. It is available in two sizes.

Features:

- Foot restraint and heel cups
- Trunk support
- Lateral and front to back adjustments provide feet and ankle alignment
- Knee blocks
- Tray
- Four 4" wheels with locking casters
- Lateral and height adjustment and two positions of depth maintain hip-knee-foot alignment and assist in abduction
- Curved rigid posterior pelvic stabilizer
- Swings open for easy transfer of child. Adjustable for an exact fit
- Height adjustable. Secured with hook and loop strap and a secondary buckle for safety
- Horizontal positioning device is angle and height adjustable

09 142 3946 Small

09 142 3953 Medium

Specifications

	Small	Medium
Height from Footrest to Tray	457-737mm	648-1105mm
Frame Width	483mm	483mm
Base Footprint	559 x 584mm	559 x 584mm
Tray Size	457 x 584mm	457 x 584mm
Knee Block Width	64mm	89mm
Knee Block Height	76mm	102mm
Pelvic Stabiliser Width	381mm	381mm
Pelvic Stabiliser Height	76mm	102mm
User Height (approx)	635-1041mm	838-1448mm

Maximum user weight



2



2



2 Tugs Paediatric Supine Stander with Tray

Supports children 760 to 1270mm (30 to 50") tall at the head, trunk, pelvis, knees and feet. Simply use the hand crank to tilt the board vertically and horizontally at any angle. For those with sufficient head control, the top 356mm (14") of the board easily folds away. Armrests fold down as well for easy entry and adjust for tray tilt. Telescoping legs extend for stability while in use and retract for convenient storage. The footboard also folds flat for storage. 75mm (3") double locking castors prevent roll and swivel. The board is 1295mm (51") and includes padding, footboards, adjustable armrests, two 102mm (4") leg straps, one 102mm (4") chest strap and two pairs of support blocks. Tray is included.

4618

Maximum user weight



3



3



3 Tumble Forms 2™ Prone Mobile Stander

Sammons Preston

The Prone Mobile Stander gives the child who cannot stand independently the freedom to mobilise at peer level. The dynamic design combines comfortable prone support with easy mobility. Wheels are slanted inward so they're easy to reach and encourage increased range of motion. The stander features padded lateral supports which adjust in both depth and length to provide flexibility in positioning. It also features a split footplate that can accommodate leg length discrepancies. User height range: 760-940mm (30-37"). Wheel diameter: 510mm (20").

4616

Maximum user weight



DELIVERY
Delivery is approximately 4 to 6 weeks. Please contact Customer Services for more information.



SPARES
Spares are available for these products, making them suitable for refurbishment. For full spares listing, please see pages 1353 to 1360.

1 Mini-Standy

This vertical standing frame helps the child to achieve a posturally correct and safe position. The frame is attached to a support surface allowing the child to interact and participate actively with their physical and social environment. The Mini-Standy can be used in a range of settings such as the home, school or clinic. A range of accessories are available to offer additional support to the child. The standing frame includes pelvic and chest support, knee pads, table and heel rest.

Features Include

- Smooth contoured frame to allow trunk rotation and sideways arm movement
- Slightly flexible wooden base to stimulate hypotonus
- Heel rests adjustable in width and depth
- Knee pads with adjustable width, depth and height
- Removable activity table adjustable in height and depth
- Braked rear castors

Technical Specifications

	Small	Large
Girth Support	600mm	700mm
Support Width	240mm	300mm
Kneepad to footboard	170-360mm	200-470mm
Footboard Width	600mm	650mm
Footboard Length	650mm	750mm
Table to Footboard	560-780mm	700-1000mm
Chest Support to Footboard	700-900mm	850-1100mm
Pelvic Support to Footboard	550-680mm	650-850mm
Total Width	700mm	700mm
Total Length	820mm	880mm
Weight	21kg	23 ¹ / ₂ kg

Maximum user weight



09 115 7874 Small

09 115 7890 Large

2 Varyflex Stander

A lightweight stander that provides a variable choice of flexibility in movement for children. Encourages muscle toning and different activities, such as reaching. Height 810mm (32"), width 475mm (19"), depth 419 (16¹/₂"). When attaching the Varyflex Tray, the Varyflex Stander is not supplied with pre-drilled holes. Some minor self assembly is required.

AA75420

Accessories

AA75422 Varyflex Tray

3 Hugs Vertical Stander

A durable, functional stander that provides children with the therapeutic benefits of standing with four points of support: chest, pelvic, knee and foot restraints. Places children at peer level. Stand detaches for storage or transport. All supports are height adjustable. Detachable tray included.

Height of Child

4620 Little Hug Stander
810-1070mm (32-42")

4630 Big Hug Stander
1090-1350mm (43-53")

Little Hug Stander

Maximum user weight



Big Hug Stander

Maximum user weight



SPARES
Spares are available for these products, making them suitable for refurbishment. For full spares listing, please see pages 1353 to 1360.



1



BIRILLO SMALL

1 Birillo™

The Birillo was conceived and designed to allow children to be able to move independently when in the sitting position. Recommended for children between the ages of 2 and 8. The triangular sitting position prevents extreme hip and trunk extension and encourages correct head and trunk posture. The abduction block supports correct posture for the pelvis. This stimulates the movement of the arms and the rotation of the trunk. The colourful and friendly appearance of Birillo encourages a child to think of it as a toy and stimulates them to safely explore their environment. This aids the development of their perceptual awareness and motor visual functions. Birillo is available in four sizes and has a range of accessories that extend its use. The height adjustable frame is made from epoxy-coated steel and the upholstery is made from fire resistant material. The padded seat has a plastic coating for extra protection from wear and tear and to aid cleaning and hygiene. The wheels have bumpers on for added protection. The handlebar is both height and depth adjustable.

- AA75808XS** X-Small
- AA75808S** Small
- AA75808M** Medium
- AA75808L** Large

Accessories

- AA75809XS** Headrest X-Small
- AA75809S** Headrest Small
- AA75809M** Headrest Medium
(Medium also suitable for Large Birillo)
- AA75825XS** Table X-Small
- AA75825S** Table Small
- AA75825M** Table Medium
- AA75825L** Table Large
- 09 116 8459** Abduction Block X-Small
- 09 116 8467** Abduction Block Small
- 09 116 8475** Abduction Block Medium



BIRILLO MEDIUM



BIRILLO LARGE

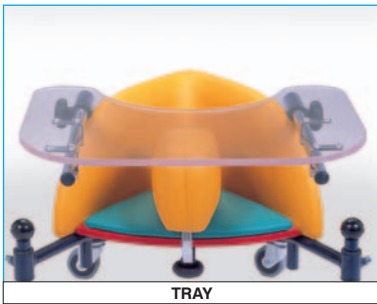

TRAY



HEADREST

Birillo Walker - Specifications

	X-Small	Small	Medium	Large
Weight	8.5kg	10kg	11kg	12.8kg
Seat Depth	180mm	200mm	130mm	300mm
Seat Width	220mm	260mm	300mm	380mm
Overall Width	590mm	650mm	730mm	780mm
Overall Length	480mm	490mm	570mm	580mm
Height Range	340-480mm	380-540mm	400-600mm	480-600mm
Leg Height Range	170-250mm	200-280mm	200-320mm	200-380mm
Maximum User Weight	30kg	40kg	50kg	60kg

SPARES
Spares are available for these products, making them suitable for refurbishment. For full spares listing, please see pages 1353 to 1360.





1 **Dynamico™**

The Dynamico Walker is designed to give independence to children and adults. It aids the development of balance and aids in the training and development of unassisted walking. It enables a child to walk without help when independent walking is not yet possible. Five sizes of Dynamico Walkers are available for indoor use and four sizes that are suitable for outdoor use. Features include:

- A non-toxic epoxy varnished chrome plated frame
- All the castors have brakes and bumpers for added protection
- A height adjustable, padded axillary support for greater comfort and stability
- A height and depth adjustable, padded pelvic support for greater comfort and stability
- Includes an adjustable, removable and washable padded harness that provides extra support

Indoor Dynamico Walker

AA75871XS X-Small

AA75871S Small

AA75871M Medium

AA75871L Large

AA75871XL X-Large

Outdoor Dynamico Walker

AA75872S Small

AA75872M Medium

AA75872L Large

AA75872XL X-Large

Accessories

A wide range of accessories are available to extend the use of the Dynamico Walkers:

- AA7587101XS** Arm Supports - Pair X-Small
- AA7587101S** Arm Supports - Pair Small/Medium
- AA7587101L** Arm Supports - Pair Large
- AA7587101XL** Arm Supports - Pair X-Large
- AA7587102XS** Weight Bar X-Small
- AA7587102S** Weight Bar Small
- AA7587102M** Weight Bar Medium
- AA7587102L** Weight Bar Large
- AA7587102XL** Weight Bar X-Large
- AA7587103** Front Wheels with Adjustable Brakes (fits all sizes)
- AA7587104** Back Wheels with Direction Locks (fits all sizes)
- AA7587105XS** Adjustable Handlebar X-Small
- AA7587105S** Adjustable Handlebar Small
- AA7587105M** Adjustable Handlebar Medium
- AA7587105L** Adjustable Handlebar Large (also fits X-Large Dynamico Walker)
- AA7587106XS** Leg Divider X-Small
- AA7587106S** Leg Divider Small
- AA7587106M** Leg Divider Medium
- AA7587106L** Leg Divider Large
- AA7587106XL** Leg Divider X-Large
- 09 115 6231** Table X-Sml-Med
- 09 115 6249** Table X-Large
- AA7587108S** Abduction Block Small
- AA7587108M** Abduction Block Medium
- AA7587108L** Abduction Block Large
- AA7587108XL** Abduction Block X-Large



Dynamico Walker - Specifications

	X-Small	Small	Medium	Large	X-Large
Weight	12kg	14.6kg	15.6kg	17kg	19.7kg
Max User Weight	55kg	70kg	85kg	100kg	115kg
External Depth	790mm	840mm	880mm	950mm	1060mm
External Width	660mm	660mm	660mm	710mm	770mm
Height to Pelvic Pad	440-600mm	660-820mm	770-1020mm	850-1120mm	980-1200mm
Height to Axillary Pad	520-770mm	770-950mm	890-1160mm	920-1260mm	1080-1430mm
Depth of Axillary Pad	170mm	200mm	240mm	290mm	310mm
Width of Axillary Pad	240mm	270mm	290mm	340mm	400mm

SPARES
Spares are available for these products, making them suitable for refurbishment. For full spares listing, please see pages 1353 to 1360.

1

NEW



SMALL

1 Trekker Gait Trainer

The Trekker Gait trainer is a versatile walker designed to help children with the development of balance and unassisted walking. The walker provides a large amount of support and requires very little weight bearing by the child. It can be used in either the anterior (forward facing) or posterior (rear facing) position to suit the child's needs.

Features:

- Height adjustable in 25mm (1") increments
- Can be used in the anterior and posterior position
- Swivel casters have swivel locks, variable resistance, brakes and one-direction locks
- Accessories mount tool-free onto the frame and can be removed or added according to the individual user's need and abilities
- Junior & Youth Trekkers fold easily

Maximum User Weight

09 142 1874	Small	34kg (5 ¹ / ₄ st)
09 142 1890	Medium	68kg (10 ¹ / ₂ st)
09 142 1908	Large	90kg (14 ¹ / ₂ st)

Accessories

Forearm Platforms

The optional forearm platforms are height and depth adjustable. The platforms can rotate and be angled forwards or backwards to accommodate a variety of positioning requirements. The platforms can be mounted anywhere on the handlebar and the contoured armrest has arm and wrist straps.

09 142 1924	Small
09 142 1932	Large

Handgrips

Handgrips can be mounted anywhere on the handlebar and they are height adjustable and rotate.

09 142 1940

Ankle Prompts

Length adjustable, padded ankle straps maintain legs and/or feet in abduction and prevent scissoring. The spring clips control stride length. Can be used for patients with, poor motor control, ataxia and excessive adduction.

09 142 1957	Small
09 142 1965	Medium
09 142 1973	Large

Hip Positioner & Pad

These length adjustable straps assist in weight bearing allow the child to concentrate on their walking motion. The posterior straps clip onto the set of handgrips included and the anterior straps can be mounted either on the handlebar, trunk support crossbar or the forearm platform or crossbar mounting post. The removable pad provides cushioned comfort.

09 142 1981	Small
09 142 1999	Large

Trunk Support

The trunk support holds the torso at the desired angle. The support is height, depth, width and angle adjustable and padded for cushioned comfort. It stays open for easy transfers and can be mounted towards the inside or outside of handlebar. Straps adjust the fit and the angle of the user

09 142 2005	Small
09 142 2013	Medium
09 142 2021	Large

Thigh Prompts

The optional thigh prompts move with the child's gait pattern allowing weight shifting from one leg to the other, whilst preventing leg scissoring. The prompts are height adjustable and can be positioned further from or closer to the user to limit adduction/abduction.

09 142 2039	Small
09 142 2047	Large

1

NEW



MEDIUM

1

NEW



MEDIUM SHOWN WITH FOREARM PLATFORMS, ANKLE PROMPTS AND THIGH PROMPTS

1

NEW



LARGE

1

NEW



LARGE SHOWN WITH FOREARM PLATFORMS, TRUNK SUPPORTS, HIP POSITIONER AND ANKLE PROMPTS

Trekker Gait Trainer - Specifications

	Height	Width	Depth	Maximum User Weight
Small	394 - 495mm	572mm	686mm	34kg (5 ¹ / ₄ st)
Medium	533 - 660mm	660mm	813mm	68kg (10 ¹ / ₂ st)
Large	711 - 965mm	699mm	965mm	90kg (14 ¹ / ₂ st)

1 Nimbo Posture Walker

This lightweight safety walker supports the user from behind to promote a more upright posture and trunk extension. A ratchet mechanism on the rear wheels prevents the walker from rolling backwards while soft rubber wheels adhere to a variety of surfaces and will not allow the walker to slide backwards. An anti-reverse override bracket disengages the one directional rear wheels to allow forward and backward mobility. Folds easily for transportation and storage.

Features

- Front swivel wheels enhance manoeuvrability and ease of turning
- A locking mechanism easily switches front wheels from swivel to non-swivel
- Skid resistant, non-marking and easy rolling wheels are ideal for indoor and outdoor use
- Latex free hand grips have flanged ends and place the users arms at their side

- 09 116 7832** Small Yellow
- 09 116 7840** Medium Green
- 09 116 7857** Large Blue
- 09 116 7865** X-Large Dark Blue
- 09 142 9430** XX-Large Red **NEW**

2 Pelvic Stabiliser for Nimbo Posture Walker

The pelvic stabiliser is adjustable in width and features back and lateral pads and a support belt. It is recommended for users who have an asymmetrical posture when standing or walking and cannot stay centred in the walker.

- 09 116 7873** Suitable for use with all sizes

3 Forearm Platform for Nimbo Posture Walker

Constructed of lightweight aluminium, the Nimbo forearm platforms are height and depth adjustable. The handgrips extend forward or back to the position needed and are angle adjustable. Each side is individually adjustable and allows custom positioning for each user. Suitable for use with all sizes.

- 09 142 9265** Small **NEW**
- 09 120 2530** Large

4 Seat Harness

This adjustable sling seat supports the user if they cannot stand completely on their own.

- 09 116 7907** Seat Harness for Small, Medium and Large Nimbo
- 09 116 7915** Seat Harness for X-Large Nimbo

5 Seat

This seat mounts on to the standard walker. They fold up for standing and walking and down for convenient seating. Retro fits on existing walkers.

- 09 118 5909** Small
- 09 118 5917** Medium
- 09 118 5925** Large
- 09 118 5933** X-Large
- 09 142 9448** XX-Large **NEW**



Nimbo Posture Walker - Specifications					
	Small	Medium	Large	X-Large	XX-Large
Handlebar Height range	368-470mm	483-635mm	584-775mm	724-914mm	96-1054mm
Overall Width	533mm	559mm	635mm	648mm	737mm
Width inside Handlebars	343mm	343mm	381mm	406mm	470mm
Depth opened at base	635mm	737mm	838mm	914mm	1016mm
Weight	4kg	5kg	51/2kg	6kg	7¼kg
Maximum User Weight	45kg (7st)	45kg (7st)	90kg (14¼st)	90kg (14¼st)	125kg (19½st)

1



1 Crocodile Reverse Walker

The Crocodile reverse walker is designed to facilitate postural alignment, balance and phases of walking. It encourages a more upright posture, improves upper extremity position, helps develop balance and encourage the correct walking posture. Optimal support is given whilst at the same time allowing freedom of movement. The Crocodile is manoeuvrable and very sturdy, suitable for indoor and outdoor use and folds for easy transportation and storage. It is available in two sizes and has a full range of optional extras. As standard it comes with adjustable (height and width) handles, anti-reverse wheel stops and swivel front wheels with directional stabilisers.

Specifications	Small	Large
Height	490-660mm	650-820mm
Height To Handles	420-560mm	550-690mm
Width	620mm	690mm
Width Between Handles	270-550mm	320-600mm
Length	720mm	840mm
Weight	5.5kg	6.5kg
Max user weight	30kg	45kg
Max user height	1150mm	1500mm
AA75889S	Small	Yellow
AA75889L	Large	Red
09 115 8252	Large	Black

Small	Large
Maximum user weight 30 kg	Maximum user weight 45 kg
4 1/2 st	7 st

Accessories

AA7588901S	Forearm Supports w/Handgrip - Small
AA7588901L	Forearm Supports w/Handgrip - Large
AA7588902	Anti-Tips, Swing-Away - Set - Fits both
AA7588903	Back Support Fits both
AA7588904	Hip Supports - Set Fits both
AA7588905S	Seat Small
AA7588905L	Seat Large
AA7588906S	Sling Seat Small
AA7588906L	Sling Seat Large



1



1



2



2 Pluto Reverse Walker

The Pluto Walker helps children to move independently while providing support from behind to promote an upright posture when standing and walking. It is designed to train natural walking movements and develop the child's sense of balance. The back wheels have a braking system, which prevents the walker from rolling back. The powder coated aluminium frame is lightweight and brightly coloured to appeal to children. The walker has height and width adjustable handgrips, steerable front wheels (front-wheels with a steerlock available separately) and folds easily for storage and transportation. Available in two sizes.

Specifications

	Small	Large
Length	750mm	800mm
Width	660mm	680mm
Handle Height	420-725mm	500-805mm
Handle Width	240-460mm	240-460mm
Weight	6.2kg	6.6kg

Maximum user weight 60 kg	9 1/4 st	80 kg	12 1/2 st
----------------------------------	-----------------	--------------	------------------

09 115 8211 Small
09 115 8229 Large

Accessories

09 115 8237 Front-wheels with steerlock

DELIVERY
 Delivery is approximately 2 weeks. Please contact Customer Services for more information.

1 Troja X Rollator

Small adults and children require a light, easy to manoeuvre product which supports their mobility. From this the Troja X has been born. The Troja X is a lightweight aluminium rollator that allows the user to be more active and provides support while offering freedom of movement. With only a few hand movements the Troja X can be folded compactly and then be ready to transport. The Troja X allows the user to be mobile and adding accessories such as the drink bottle holder and using the standard fitted multi use net bag to carry toys, etc makes it extremely user friendly.

Features

- The built in memory function, always remembers the user's set handle height. Put down the handles during transport, open and pull up and they stop at your settings again.
- Due to the fantastic design the rollator can tackle obstacles such as kerbs. Tread on the left or right kerblifter to raise the Troja at the front then keep on walking forward until the obstacle has been passed
- The Troja can be folded with one hand and very little effort. Just pull lightly on the grey strap in the middle of the seat and the rollator seems to fold itself in your hands.
- In the folded position the Troja X takes very little space. It stands secure and safely on all four wheels. Ideal for small rooms or can also be stored behind a door.
- The net seat and the excellent parking brakes allow the user to sit safely and take a break

09 142 2062 Troja X Rollator

09 142 2294 Backrest

09 142 2302 Bottle Holder

09 142 2310 One Hand Brake

Maximum user weight **80 kg** **12 1/2 st**



Troja X Rollator - Specifications

Recommended user height	1250 – 1600mm (4ft 1" - 5ft 3")	Diameter front / rear wheels	200mm (7¾")
Height of support points	635 – 790mm (25" – 30¼")	Width front/rear wheels	36mm (1¼")
Maximum length	650mm (25½")	Grip distance driving brake	65mm (2½")
Maximum width	525mm (20¾")	Height when folded up	650mm (25½")
Between support points	370mm (14½")	Width when folded up	250mm (9½")
Seat height	520mm (20½")	Length when folded up	660mm (26")
Turning diameter	840mm (33")	Weight	6.6 kg (14lbs 5oz)

2 Atila Posture Walker

The bright yellow frame makes this rollator walker popular with children. Double castor wheels in front make steering easy, and rear wheels allow smooth rolling with no need for lifting. Hand brakes, adjustable to child's ability, provide safety and control. Generous space between wheels accommodates wide or uncoordinated gaits. A great walker for children with cerebral palsy, spina bifida, and other disorders who have good upper body strength and control, but limited endurance. Folds for convenient transportation and storage. Maximum user height 1100mm (3'8"). Walker weight 6kg (13lbs). Handle height adjusts 570 to 800mm (22½ to 32"). Overall walker width 570mm (22½"). Overall walker length 570mm (22½"). Diameter of wheels 150mm (22½")

926863 Walker

926864 Tray - Doubles as seat support

926865 Seat Cushion - Rubber

Maximum user weight **40 kg** **6 1/4 st**



1



1 Fixi Aluminium Rollator

This children's rollator is exceptionally lightweight due to its powder coated aluminium construction and the brightly coloured frame makes it very appealing to children. The lightweight design allows the child to move more easily and is suitable for children with limited endurance. The airless tyres allow smooth rolling with no need for lifting and dual action brakes provide both safety and control for the child. Folds easily for storage and transportation. Seat and back supports are available as accessories. The Fixi has 5 height adjustments from 600-690mm (23¹/₂-21¹/₄") and is suitable for users up to 100kg (15³/₄st).

AA75873 Multi-coloured

Specifications

Front to Back Size	625mm (24 ¹ / ₂ ")
Width	575mm (22 ¹ / ₂ ")
Height	600-690mm (23 ¹ / ₂ -27"
Seat Height	425mm (16 ³ / ₄ ")
Weight	5.2kg

Maximum user weight **100 kg** **15³/₄ st**

Accessories

- AA75875** Seat
- AA75876** Back Support

2 Fox Aluminium Rollator

A lightweight, aluminium rollator designed to accommodate larger children and adolescents. The lightweight powder coated aluminium frame supports users up to 100kg (15³/₄st). Airless tyres allow smooth rolling allowing the child to move more easily and dual action brakes provide safety and control for the user. Folds easily for storage and transportation. A seat, back support and basket are available as accessories. The Fox has 5 height adjustments from 690-770mm (27¹/₄-30¹/₄").

AA75874 Multi-coloured

09 115 8245 Blue

Specifications

Front to Back Size	670mm (26 ¹ / ₂ ")
Width	575mm (22 ¹ / ₂ ")
Height	690-770mm (27 ¹ / ₄ -30 ¹ / ₄ ")
Seat Height	500mm (19 ³ / ₄ ")
Seat Width	420mm (16 ¹ / ₂ ")
Weight	5.3kg

Maximum user weight **100 kg** **15³/₄ st**

Accessories

- AA75875** Seat
- AA75876** Back Support
- AA75877** Basket

2



FOX I ROLLATOR PICTURED WITH OPTIONAL SEAT

2



1 Wheeled Walking Frame

A lightweight aluminium walking frame with non-slip ferrules at the rear and wheels at the front. Contoured hand grips offer improved grip for the child. Height adjustable from 560 to 660mm in 20mm increments to suit a number of users and adapt as the child grows. Back width 460mm. Front width 300mm. Weight 1.7kg.

09 115 8278

Maximum user weight **100 kg** **15³/₄ st**

2 Adjustable Walking Frame

This lightweight aluminium walking frame has grey non-marking, non-slip ferrules to provide stability. Contoured hand grips offer improved grip for the child. It is height adjustable from 550 to 650mm in 20mm increments to suit a number of users and adapt as the child grows. Back width 460mm. Front width 300mm. Ferrule tip size 25mm. Weight 1.5kg.

09 117 1164

Maximum user weight **100 kg** **15³/₄ st**

3 Children's Walking Frame

This lightweight aluminium walking frame is made from steel reinforced anodised aluminium and has an ergonomic handle for a comfortable grip. The frame is height adjustable from 710 to 810mm (28 to 31³/₄") to suit a number of users and adapt as the child grows. Width 520mm (20¹/₂"). Depth 350mm (13³/₄"). Rotation diameter 540mm (21¹/₄"). Handle diameter 45mm (1³/₄"). The non-slip ferrules are 42mm in diameter. Weight 1.2kg.

09 115 8260

Maximum user weight **100 kg** **15³/₄ st**

4 Glider Walker

This lightweight aluminium walker has an aluminium frame with adjustable handles and legs. The wide base provides stability and balance, while the airless tyres are suitable for both indoor and outdoor use. The height can be adjusted easily without the need for tools. The medium and large sizes have a 90° handle and the small model has a 45° handle. Colour may vary.

09 117 1180 Small

09 117 1198 Medium

09 117 1206 Large

Accessories

09 117 1214 One Directional Front Wheels (pair) Small

09 117 1222 One Directional Front Wheels (pair) Medium

09 117 1230 One Directional Front Wheels (pair) Large

09 117 1248 Platform Attachment Small

09 117 1255 Platform Attachment Medium

09 117 1263 Platform Attachment Large

09 117 1271 45° Handles (pair) Medium

09 117 1289 45° Handles (pair) Large

Specifications

	Small	Medium	Large
Width (Inside Back Legs)	559mm (22")	610mm (24")	711mm (28")
Depth (Opened at Base)	508mm (20")	635mm (25")	635mm (25")
Maximum Height Setting	533mm (21")	838mm (33")	940mm (37")
Minimum Height Setting	305mm (12")	559mm (22")	737mm (29")
Weight	2.5kg	3.2kg	3.6kg

Maximum user weight **79 kg** **12¹/₂ st**



1



BEST SELLER

2



3



4

Tumble Forms 2™
With Anti-Microbial Protection



5



6



1 Children's Double Adjustable Elbow Crutches

These lightweight aluminium children's crutches have standard hand grips and are adjustable in height between the elbow and hand, and the hand and the ground. The angled neck reduces strain on wrists and the closed armband means that the user can retain the crutch on their arm, even if handle is released. Each crutch has a non-marking, slip resistant ferrule. Handle to armband: 170mm (6¾") to 220mm (8¾"). Handle to Ground: 560mm (21½") to 800mm (31½"). Sold in pairs.

121JDA
Maximum user weight **100 kg** **15¾ st**

2 Rebotec Children's Crutches

Strong, lightweight aluminium crutches finished in bright coloured plastic, designed specifically for children. The handle height is adjustable by 225mm and there are three settings for the forearm half cuffs. The crutches have 10 height settings. Each crutch comes with a large, non-slip ferrule and the handle incorporates a reflector for extra safety. The crutch's height range is 490 to 715mm (19¼ to 28¼"). Sold in pairs.

AA75898
Maximum user weight **100 kg** **15¾ st**

3 Rebotec Children's Quad Crutch

Strong, lightweight aluminium crutch finished in bright coloured plastic, designed specifically for children. This tetrapod design has four high-grip feet that give a stable and firm platform. The crutch provides a choice of 10 height settings. The handle height is adjustable by 220mm. The handle end incorporates reflectors for extra safety. The crutch's height range is 630 to 855mm (24¾ to 33¾"). Sold individually.

AA75899
Maximum user weight **100 kg** **15¾ st**

4 Tumble Forms 2™ Scooter Board Sammons Preston

Covered with special Tumble Forms 2™ coating, this child-friendly padded scooter board helps develop children's neuro-motor control as they propel themselves in any direction. The scooter board has two handles for the child to hold and the covering is both washable and waterproof. Benefits from hard-wearing 51mm (2") castors. Measures 610mm (24") in diameter.

4814B
Maximum user weight **45 kg** **7 st**



5 Height Adjustable Crawler Sammons Preston

Aids elementary crawling when body support is required and encourages crawling without regard for specific patterns. The waterproof leatherette body support tilts forwards or backwards for correct positioning and encourages vestibular responses. Height adjusts from 295 to 385mm (11½ to 15¼"). Suitable for children aged 3 to 9 years.

8192
Maximum user weight **40 kg** **6¼ st**

6 Plastic Scooter Boards

Used in a sitting, kneeling, or prone position, the scooter board can help develop co-ordination and gross motor skills of the upper and lower extremities. The 300 x 300mm (12 x 12"), heavy-duty polypropylene scooter has safety-grip handles and non-marring rubber swivel castors.

4841 Scooter Board
Maximum user weight **79 kg** **12¼ st**

SPARES
Spares are available for these products, making them suitable for refurbishment. For full spares listing, please see pages 1353 to 1360.

Tumble Forms 2[™]

With Anti-Microbial Protection

1 Tumble Forms 2[™] Jettmobile

Sammons Preston

The Jettmobile facilitates the development of upper extremity strength and endurance and incorporates sensory stimulating activity. Helps to develop neck, shoulder and arm muscle co-ordination while the child advances in an extended position. It has ball castors that are safely concealed by protective fenders and it is provided with an abductor wedge, chest wedge, two small positioning half moon shapes and a hip strap. Available in two sizes.

	Child's Height	Length
4768C	Child Up to 1020mm (40")	710mm (28")
4769C	Adolescent Up to 1520mm (60")	970mm (38")

Also available without accessories

- 476801** Child
- 476901** Adolescent

Child	Adolescent
Maximum user weight 56 kg 8 3/4 st	Maximum user weight 90 kg 14 3/4 st

Accessories

All fit both child and adolescent sized Jettmobile

- 924769** Half Moon Spacer - Pair
- 928301** Spare Castor with Brake - Individual
- 928302** Spare Castor without Brake - Individual
- 4768B** Abductor Wedge
- 9101** Accessory Wedge, 280 x 254 x 64mm
- 9107** Buckle Strap, 1015mm (40")
- 9108** Buckle Strap, 1118mm (44")



2 Tumble Forms 2[™] Ready Racer

Sammons Preston

This is a pre-wheelchair mobility aid that combines wheelchair handling with fun, sports car styling. It helps to improve motor skills, strengthens the arms and upper trunk and allows the child to play at peer level. Designed for indoor use, the Ready Racer is easily manoeuvred in tight spaces and moves easily over carpet and rough surfaces. It requires minimal arm strength to move it. The chassis is made from high density foam and covered with a moisture proof, easy to clean covering.

The rear tyres are pneumatic. The ergonomic seat has 15° flexion at the knee and a 90° seat-back angle. It has a safety hip strap set at 45°. The low front allows easy self-transfer.

It is recommended for children aged 18 months to 5 years.

A handle that adjusts from 600 to 914mm (24 to 36") is available as an accessory.

Overall size: Length 890mm (35"). Width 560mm (22").

Depth 510mm (20").

Inner seat size: Length 584mm (23"). Width 241mm (9 1/2").

Depth 342mm (13 1/2"). Weight 13.2kg.

- 4770R** Ready Racer

Accessories

- 4770RA** Optional Adjustable Handle
- 928287** Hip Strap
- 928303** Spare Wheel Castor

Maximum user weight 25 kg 4 st
--



PICTURED WITH OPTIONAL ADJUSTABLE HANDLE

SPARES
Spares are available for these products, making them suitable for refurbishment. For full spares listing, please see pages 1353 to 1360.

1



1 Special Tomato® EIO Pushchair

The Special Tomato® EIO Pushchair is intended to be used with children in early intervention all the way through to 8 years of age. With the EIO Pushchair, standard features include the padded hip and back laterals that help to decrease the overall width of the stroller. As the child grows, these can be removed. Special Tomato® Liners or the Special Tomato® Sitters offer more support for smaller children. As they grow, they can be removed for instant increased seat width and depth. The pushchair offers seat back recline from 25° to 75°, footrest elevation, and 8 potential years of growth.

The EIO includes lots of storage as standard features: large shopping basket under the seat, two water bottle holders and a large pocket for keys, mobile phones etc on the back of the canopy.

Features

- Reclining seat and elevating footrest to support the child
- Locking large airless swivel wheels
- Lightweight design only 10kg
- Optional Special Tomato® Soft Touch Liners are available to allow the child to grow with the pushchair
- 5-Point Comfort Wrap harness with chest strap and shoulder pads
- One-touch rear brake
- Spring suspension
- Latch to keep the pushchair folded while transporting or storing it
- Folds compactly for transport
- Legrest angle adjustment from +15 degrees to -55 degrees
- Push handle angle adjustment from +60 degrees to -65 degrees

09 120 3033 EIO Pushchair

Optional Sitters & Liners

Soft-Touch™ Liners		
Seat Cushion		
Cherry	Lilac	
09 116 4979	09 118 2351	Size 1
09 116 4995	09 118 2377	Size 2
Back Cushion		
Cherry	Lilac	
09 116 4987	09 118 2369	Size 1
09 116 5000	09 118 2385	Size 2
Soft-Touch™ Sitters		
Chocolate/Tan Chocolate/Lilac		
553376	09 118 6147	Size 1
553377	09 118 6154	Size 2

Maximum user weight **40 kg** **6 1/4 st**

INFORMATION
This product is not suitable for use during transportation in a vehicle.

1



1



1



1



1



Specifications

Seat Width	355mm (14")
Seat Width With Pads at Most Narrow Point	229mm (9")
Seat Depth	305mm (12")
Seat Back Height	610mm (24")
Seat to Footwell - Pushchair Only	330mm (13")
Seat to Footwell - with Liners	380mm (15")
Seat to Footwell - with Size 1 Sitter	406mm (16")
Seat to Footwell - with Size 2 Sitter	430mm (17")
Handle Height to Floor	760-1067mm (30-42")
Handle Height to Floor	+60° to -65°
Footwell Angle to Floor	+15° to -55°
Seat Recline Range (from upright)	25° - 75°
Overall Dimensions (width x length x height)	610 x 1170 x 1140mm (24 x 46 x 45")
Folded Dimensions (width x length x height)	610 x 940 x 457mm (24 x 37 x 18")
Folded Dimensions without Rear Wheels (width x length x height)	559 x 940 x 457mm (22 x 37 x 18")
Weight of Stroller	10 kg
Wheel Diameter (front & back)	229 & 279mm (9" & 11")

1 Special Tomato® Jogger

A lightweight, all terrain pushchair designed for children requiring minimal to moderate positioning. It has a lightweight aluminium frame with a swivelling front wheel that can also be locked in place if required. The comfortable padded seat reclines and the protective canopy has a window so that the child is visible at all times. The Soft-Touch™ Liner easily attaches to offer contoured body support for additional positioning and the pushchair still folds easily with the Soft-Touch Liner in place. Folds easily for storage of transportation. Latex free.

Standard Features

- Three 305mm Pneumatic Tyres
- Locking Front Swivel Wheel
- Hand-Operated Front Disc Brake
- Foot Well with Side-Guard
- Functional Rear Suspension
- Foot-Operated Rear Parking Brake
- Quick-Release Rear Wheels
- Removable Padded Upholstery
- Reclining Back Support
- Height Adjustable Handle
- Removable Canopy
- 5-point harness

09 115 8336 Special Tomato Jogger

Accessories

09 115 8344 Medical Bag

09 115 8351 Head Support

Soft-Touch™ Liners

Seat Cushion

Cherry Lilac

09 116 4979 **09 118 2351** Small

09 116 4995 **09 118 2377** Medium

Back Cushion

Cherry Lilac

09 116 4987 **09 118 2369** Small

09 116 5000 **09 118 2385** Medium

Soft-Touch™ Sitters

Chocolate/Tan Chocolate/Lilac

553376 **09 118 6147**

Maximum user weight **50 kg** **7 ¾ st**

i INFORMATION This product is not suitable for use during transportation in a vehicle.

Special Tomato Jogger - Specifications

Weight	12.25kg
Seat to Foot-well	381mm (15")
Seat Width	356mm (14")
Seat Depth	305mm (12")
Back Height	559mm (22")
Total Width	660mm (26")
Total Length	1067 (42")
Total Height	1092mm (43")
Handle Height - to floor	889-1092mm (35-43")
Folded Dimensions (without rear wheels)	533-838mm (21-33")
Recline Range	100°-140°



FUNCTIONAL REAR SUSPENSION & REAR PARK BRAKE



JOGGER WITH SOFT-TOUCH™ SEAT & LINERS



ADJUSTABLE HANDLE

1



1 Special Tomato® Buggy

The stylish Special Tomato Buggy is durable, strong and lightweight due to its aluminium frame and accommodates children from birth to 25kg. The adjustable comfort-wrap harness and adjustable padded shoulder straps allow the stroller to 'grow' with the child, extending the life of the Tomato Buggy. For children with mild to moderate positioning needs, the small Soft-Touch™ Liners or Soft-Touch™ Sitter attach to the buggy.

Standard Features

- 3-position backrest (30°, 45°, and 65°)
- 2-position lower leg support
- 5-Point comfort wrap harness
- Padded shoulder straps
- Padded head pillow
- 150mm airless soft EVA wheels
- All-wheel spring suspension
- Swivel front wheels with lock-out feature
- "One-touch" rear brake
- Removable and adjustable hood with window
- Shopping basket

09 118 2138 Special Tomato Buggy

Optional Extras **Size** **Colour**

553376 Soft-Touch Sitter Size 1 Chocolate/Tan

09 118 6147 Soft-Touch Sitter Size 1 Chocolate/Lilac

Soft-Touch™ Liners **Size** **Colour**

09 116 4979 Seat Cushion Small Cherry

09 116 4987 Back Cushion Small Cherry

09 118 2351 Seat Cushion Small Lilac

09 118 2369 Back Cushion Small Lilac

Specification

Weight of Chair 7.25kg

Seat to Foot-well 279mm (11")

Dimensions when open

Height 1054mm (41¹/₂"

Width 489mm (19¹/₄"

Depth 794mm (31¹/₄"

Dimensions when folded

Height 1149mm (45¹/₄"

Width 286mm (11¹/₄"

Depth 286mm (11¹/₄"

Back Height 445mm (17¹/₂"

Seat Depth 229mm (9")

Seat Width 324mm (12³/₄"

Maximum User Height 1.12m (3ft 6")

Maximum user weight



1



PUSHCHAIR WITH SITTER

1



1



1



INFORMATION

This product is not suitable for use during transportation in a vehicle.

1 Maclaren Major Elite Pushchair

The Maclaren Major in stylish Charcoal and Scarlet is specially designed for disabled children.

The Major has been developed to meet the demand for an everyday buggy for children, who as a result of disability have a need for portable, parent-wheeled transport. Supplied in the basic format, the Major can also be customised with numerous accessories for added comfort.

The Major is sturdily built with a square-section, aluminium chassis and 178mm (7") wheels to withstand years of rugged service. It features front swivel wheels and ergonomically optimised handles. A three position detachable foot rest, brakes and a five-point safety harness all come as standard. The Major also has the unique Maclaren folding action for ease of handling and storage. To meet the everyday demands of children with special needs the Major features:

- Weight – 6.75kg (7.5kg with footplate)
- Sturdy lightweight frame
- Easily folded to 117 x 25 x 21 cm
- 5 point safety harness
- Adjustable leg rest and handles
- Detachable rigid footrest
- Swivel front wheels for easy manoeuvrability
- Brakes on each rear wheel

Accessories including, padded seat, lateral supports, chest pads, sunshade, boot and raincover are also available separately

AA75869 Pushchair

Please note fabric colour may vary from those shown in this catalogue

Accessories

AA7586901 Shopping Bag

AA7586903 Sunshade

AA7586904 Lateral Inserts

AA7586906 Wind/Rain Shield (can only be used in conjunction with Sunshade)

AA7586907 Stroller Boot

09 116 8988 Spare Footrest

Special Tomato® Soft-Touch™ Liners

Liners can be added to the pushchair to provide additional postural support.

Seat Cushion

Cherry Lilac

09 116 4979 **09 118 2351** Small

09 116 4995 **09 118 2377** Medium

Back Cushion

Cherry Lilac

09 116 4987 **09 118 2369** Small

09 116 5000 **09 118 2385** Medium

Maximum user weight



SPARES
Spares are available for these products, making them suitable for refurbishment. For full spares listing, please see pages 1353 to 1360.

Specifications

Seat Width	380mm
Seat Depth	250mm
Height of Seat Back	520mm
Height of Seat - from ground (front)	580mm
Height of Seat - from ground (back)	450mm
Overall Width	530mm
Height of Handles - from ground	1040mm
Distance - front edge of seat to:	
Footrest - top	200mm
Footrest - middle	250mm
Footrest - bottom	360mm
Weight of Pushchair without Footrest	6.75kg
Weight of Pushchair with Footrest	7.5kg
Maximum user weight	50kg (7 ³ / ₄ st)



SUNSHADE



STROLLER BOOT



1 Clip Pushchair™

Clip is a robust, all purpose pushchair for children. Available in four sizes, it is fully adjustable to allow for child growth and a full range of accessories are available. Its features include:

- Lightweight and foldable for easy transportation and storage
- Inclined seat to assure maximum user comfort
- Folding frame made from lightweight aluminium, coated with a non-toxic epoxy varnish
- Semi-rigid back rest that has inner aluminium supports that are adjustable to three different positions
- Semi-rigid seat with inner aluminium supports
- Detachable footrest that is adjustable in height
- The rear wheels are 200mm (7¾") in size and have brakes. The front wheels are 140mm (5½")

Yellow frame	Silver frame	
AA75860XSB	-	X-Small
AA75860SB	AA75860SS	Small
-	AA75860MS	Medium
AA75860LB	AA75860LS	Large

Please note fabric colour may vary from those shown in this catalogue

Accessories

- AA7586001S** X-Small to Small Inguinal Belts - Pair
- AA7586001M** Medium Inguinal Belts - Pair
- AA7586001L** Large Inguinal Belts - Pair
- AA7586002S** X-Small to Small Side Support
- AA7586002L** Medium to Large Side Support
- AA7586003S** X-Small to Medium Foot Straps
- AA7586003L** Large Foot Straps
- AA7586004S** X-Small to Small Headrest
- AA7586004L** Medium to Large Headrest
- AA7586005S** X-Small to Small Vest Harness
- AA7586005M** Medium Vest Harness
- AA7586005L** Large Vest Harness
- AA7586006S** X-Small to Small Chest Strap
- AA7586006L** Medium to Large Chest Strap
- AA7586007S** X-Small to Medium Retractable Canopy
- AA7586007L** Large Retractable Canopy
- AA7586008S** X-Small Small Rain Cover for use with Canopy
- AA7586008M** Medium Rain Cover for use with Canopy
- AA7586008L** Large Rain Cover for use with Canopy
- AA7586009S** X-Small to Small Thermal Cover
- AA7586009M** Medium Thermal Cover
- AA7586009L** Large Thermal Cover
- AA7586010** Wheel Direction Locks (one size fits all)
- AA7586011S** Small, 45° Pelvic Belt
- AA7586011M** Medium, 45° Pelvic Belt
- AA7586011L** Large, 45° Pelvic Belt
- AA7586012** Fixing Hooks - Set of 4
- AA7586013S** X-Small to Small Five Point Harness
- AA7586013M** Medium Five Point Harness
- AA7586013L** Large Five Point Harness



Clip Pushchair - Specifications				
	X-Small	Small	Medium	Large
Seat Depth	250mm	300mm	350mm	400mm
Seat Width	300mm	330mm	360mm	400mm
Backrest Height	600mm	600mm	650mm	670mm
Backrest Width	400mm	400mm	400mm	450mm
Distance of edge of seat to footrest	210-310mm	210-310mm	250-350mm	360-480mm
Total Width	510mm	510mm	510mm	570mm
Total Length	870mm	870mm	970mm	1050mm
Total Height	990mm	990mm	1010mm	1120mm
Folded Dimensions	1100x240x320mm	1100x240x320mm	1110x300x320mm	1170x310x470mm
Weight	10.8kg	11kg	11.2kg	12.5kg
Max User Weight	30kg	35kg	40kg	76kg



SPARES
Spares are available for this product, making it suitable for refurbishment. For full spares listing, please see pages 1353 to 1360.

1 Trotter Pushchair

The Trotter is a lightweight portable positioning chair that provides transport solutions for parents and children. A wide range of options provide custom positioning for individual needs and its simple adjustments allow the Trotter to grow with the child.

- Lightweight folding frame with closure strap that holds the chair shut when folded
- Black machine washable fabric
- Adjustable seat angle – 15° and 22°
- Adjustable back angle – 85°, 90° and 95°
- 203mm (8") front casters and 254mm (10") rear wheels with toggle lock
- Adjustable seat depth
- Positioning pelvic belt and five point "H" harness with padded strap covers. The reversible padded strap covers increase comfort and one side of cover is imitation lamb's wool and the other is velour.
- Swing-away footrest are independently adjustable and removable

- 09 118 6428** Small
- 09 118 6436** Medium
- 09 118 6444** Large
- 09 118 6451** X-Large

Accessories:

Headrest Extension

Black nylon fabric Headrest Extension is width and height adjustable. It provides additional head support for taller users.

09 118 6667

Padded Headrest Wing

Height adjustable headrest wing provides lateral support for the head.

09 118 6675

Utility Bag

Zippered bag hooks on to the back of the Trotter mobility chair.

09 118 6501

Upper Extremity Support Tray

The tray features a safety lip and are easy to clean. Provides trunk stabilisation and is great for feeding.

09 118 6477

Full Torso Vest

Adjustable vest provides support and maintains proper body posture and alignment. It replaces the "H" Harness.

09 118 6527

Canopy

Height adjustable and removable canopy provides protection from sun or rain and includes a clear flap-covered observation panel.

09 119 1352

Lateral Support & Scoli Strap

Adjustable and removable strap provides lateral support. It can be pulled to one side for Scoliosis correction.

09 118 6469

Foot & Ankle Positioner

Foot and ankle straps provide adjustable support and positioning.

09 118 6634



FOOT & ANKLE POSITIONERS



FOLDS EASILY



UTILITY BAG



OPTIONAL TRAY

Specifications				
	Small	Medium	Large	X-Large
Seat Width	298mm	349mm	394mm	445mm
Seat Depth	292-343mm	330-381mm	343-394mm	381-432mm
Back Height	508mm	584mm	610mm	635mm
Seat to Footplate	203-559mm	229-559mm	254-571mm	279-584mm
Seat to Floor	559mm	559mm	559mm	571mm
Weight	8 1/2kg	9 1/2kg	11kg	13 1/2kg
Max user weight	34kg	45kg	77kg	113kg

1



NEW

1 Racер Buggy

This comfortable buggy has been designed for children, teenagers and adults who have difficulty sitting and standing independently. The positioning wedge system, side pads and harnesses provide postural support even with very flaccid patients, offering the child comfort and safety without restriction of movement. The upholstery is made of breathable washable fabrics and the buggy is collapsible for easy transportation. Pumped wheels with brakes make the Racер easy to manoeuvre inside or out.

Features

- Collapsible frame for storage and transportation
- Angle adjustable backrest
- Length and angle adjustable footrest with foot straps
- Removable pommel
- Support vest
- Adjustable side pads
- Adjustable head rest
- Removable support rail
- Optional folding sunshade with removable rain cover

Racер Buggy

- 09 142 6014** Small
- 09 142 6055** Medium
- 09 142 6097** Large

Accessories

- Thigh Abduction Belts
 - 09 142 6139** Small
 - 09 142 6162** Medium
 - 09 142 6188** Large
- Tray
 - 09 142 6212** Small
 - 09 142 6220** Medium
 - 09 142 6238** Large
- Sunshade & Rain Cover
 - 09 142 6246** Small
 - 09 142 6253** Medium
 - 09 142 6261** Large

Maximum user weight (Small)

35 kg **5 1/2 st**

Maximum user weight (Medium)

50 kg **7 3/4 st**

Maximum user weight (Large)

60 kg **9 1/4 st**



Specifications

	Small	Medium	Large
Maximum User Height	1400mm (55")	1600mm (63")	1700mm (66 3/4")
Seat Width	300mm (11 3/4")	330mm (13")	360mm (14")
Backrest Height	650mm (25 1/2")	730mm (28 3/4")	750mm (29 1/2")
Seat Depth	350mm (13 3/4")	420mm (16 1/2")	470mm (18 1/2")
Seat to Footrest	250-400mm (9 3/4-15 3/4")	380-450mm (15-17 3/4")	350-480mm (13 3/4-18 3/4")
Maximum Backrest Decline to Seat	130°	135°	130°
Overall Width	610mm (24")	620mm (24 1/2")	690mm (27 1/4")
Overall Length	1030mm (40 1/2")	1350mm (53 1/4")	1370mm (54")
Overall Height	970mm (38 1/4")	950mm (37 1/2")	980mm (38 1/2")

1 Children's Handling Belts

These children's handling belts provide a snug fit and are designed to give the child a feeling of safety and security. The bright colourful pattern is fun for the child, aiding compliance. The belts feature horizontal and vertical handles for a variety of hand positions and a hook and loop overlap fastening ensures a good fit. Extra padding in the back provides added support and the inner fabric is breathable and resists slipping. All materials will wash at 74°C for 3 minutes. Can be safely tumble dried on a low heat. Available in small and standard.

	Size	Waist
09 117 9555	Small	457 to 559cm (18 to 22")
09 117 9563	Standard	559 to 660cm (22 to 26")



SMALL



STANDARD

2 Mini Belt

A narrow, simple handling belt with two vertical handholds and two lateral handholds. It can be used with children as well as adults. Suitable for waist sizes 508 to 1143mm (20 to 45").

AA8849



2

3 Children's Rota Pad

The Children's Rota Pad enables the child to place their feet centrally whilst the carer can stand much closer and more safely than with larger pads. It is especially useful when transferring across a transfer board as it prevents foot drag during the manoeuvre. Diameter 280mm (11").

09 117 9589



3

4 Dolphin Board

The Dolphin Board is designed for assisted and independent transfer from a wheelchair to the toilet. It has the additional benefit of remaining in position during toilet use. The wheelchair cut outs allow transfer from either side of the toilet. Strong and lightweight, the board is rigid with no flex during transfer. Length 690mm (27"). Width at widest point 380mm (15"). Weight 1.65kg.

AA8834



4

5 Hop! Lift

The reduced dimensions and friendly face design on this hoist make it the ideal choice for paediatrics. It is also excellent for use in small houses or where space is restricted. It is lightweight and dismantles into two parts for storage and transportation.

High stability, along with the correct sling choice, allows it to lift a person from the floor. A pedal system is used to open the legs of the base to facilitate use. Weight 29.3kg.

AA89028

Maximum user weight

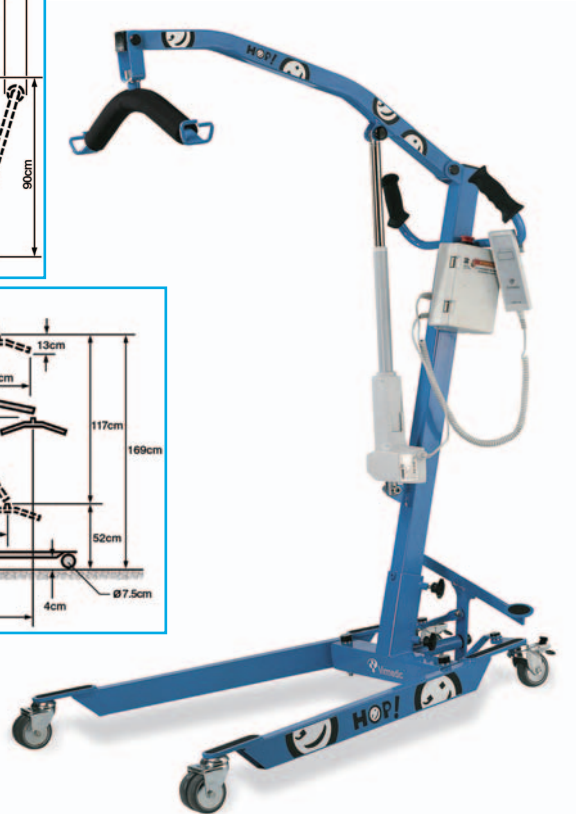
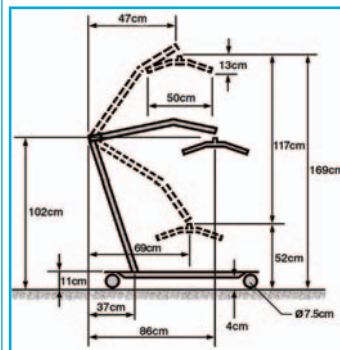
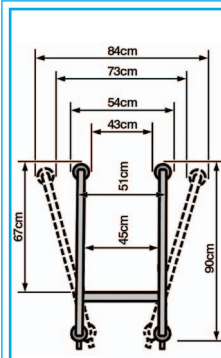

5

DELIVERY
Delivery is approximately 4 weeks. Please contact Customer Services for more information.



1 Aquaplast™ Watercolors™ Rolyan

Moderate resistance to stretch.

Handling Characteristics

- Bright and vibrant colours that encourage paediatric and adult compliance
- Features all the well loved benefits of Aquaplast-T
- Less likely to be lost in the laundry or in bedding

Heating and Working Times

- 1.6mm for 35 seconds at 70°C-75°C gives 1-2 minutes working time
- 2.4mm for 1 minute at 70°C-75°C gives 2-3 minutes working time
- 3.2mm for 1 minute at 70°C-75°C gives 4-6 minutes working time

Clinical Indications

- Hand and upper limb splinting
- Ideal for paediatrics
- Neurological visual and attentional deficits
- Occupational splints where conventional white materials can show stains

Aquaplast™ Watercolors™ Splinting Material									
		Quantity	3.2mm x 46 x 61cm		2.4mm x 46 x 61cm		1.6mm x 46 x 61cm		
			Solid	OptiPerf 19%	Solid	OptiPerf 19%	Solid	OptiPerf 19%	UltraPerf 13%
	Electric Blue	1 Sheet	A9631	A96310	-	-	A96340	A96346	A963461
	Charcoal	1 Sheet	A96332	A96321	-	09 118 2492	A96323	A96324	A963241
	Red	1 Sheet	A963110	A963111	A963112	A963113	A927953	-	A9631131
	Purple	1 Sheet	A963100	A963101	A963102	A963103	A927954	-	A9631031
	Hot Pink	1 Sheet	A9632	A96311	554567	554569	A96341	A96347	A963471
	Blush	1 Sheet	A9638	A96318	-	-	-	-	-
	Pastel Blue	1 Sheet	A96330	A96314	-	-	A927955	-	A963141
	Spring Green	1 Sheet	A9635	A96313	-	-	A927966	-	A963131
	Beige	1 Sheet	A96231	A96232	A96257	A96258	A96241	-	A962421
	Royal Blue	1 Sheet	550547	550549	-	-	550551	550553	550555
	Lavender	1 Sheet	551484	551486	-	-	551488	551490	551492

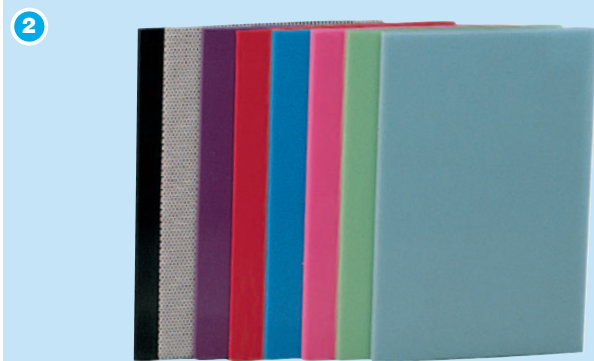

Aquaplast™ Watercolors™ Splinting Material - Case of 4

		Quantity	3.2mm x 46 x 61cm	
			Solid	OptiPerf 19%
	Electric Blue	4 Sheets	09 116 9002	09 116 9028
	Charcoal	4 Sheets	09 116 9010	09 116 9036
	Red	4 Sheets	09 116 9044	09 116 9051
	Purple	4 Sheets	09 116 9069	09 116 9077
	Lavender	4 Sheets	09 118 2500	09 118 2526

2 Aquaplast™ Watercolors™ Paediatric Pack A Rolyan

Convenient size for paediatric splinting or for hand-based splints for adults. Save time and money by ordering 15 x 23cm sheets in 8 colours: 3.2mm solid electric blue, hot pink, spring green, charcoal, pastel blue and red. 2.4mm solid purple. 1.6mm OptiPerf blush.

A963220

3 Aquaplast™ Variety Pack Rolyan

Great for the small clinic that needs to have a variety of thicknesses, colours and perforation patterns available. Contains one each of the following sheets, all of which measure 15 x 23 cm:

1.6mm Aquaplast-T white SuperPerf, 2.4mm Aquaplast-T solid white, 3.2mm Aquaplast-T Watercolours hot pink solid, 3.2mm Aquaplast Watercolours electric blue solid, 3.2mm Aquaplast Watercolours spring green solid, 3.2mm Aquaplast-T white 1% perf, 4.8mm Aquaplast-T white 1% perf.

09 117 5108



DID YOU KNOW...

...that all Rolyan thermoplastics are latex free, biodegradable and X-Ray translucent?



1 Junior Formthotics

Junior Formthotics are soft, flexible foot orthoses, especially developed for children. They are designed to help the child's foot assume its natural posture inside the shoe, thereby enhancing the development of the child's musculoskeletal system.

The most effective foot orthoses is the one that kids will wear. So with patient compliance in mind, Junior utilises some special features to provide gentle forgiving support and comfort.

Junior Medial Heel Skive:

The medial heel skive carefully increases the force the orthosis applies to the foot medial to the subtalar joint axis, reducing rearfoot eversion. This helps to manage rearfoot pronation without the need for excessive arch height in the orthosis, increasing patient compliance.

Junior Heel Cup:

The medial heel wedge carefully increases the force the orthosis applies to the foot medial to the subtalar joint axis, reducing rearfoot eversion.

Deep Heel Cup:

The deep heel cup increases the medial surface area of the orthoses next to the foot, making the heel wedge even more effective. The heel cup is also designed to wrap around the back of the foot providing additional rearfoot stability.

Wide Medial Flange:

The wide medial flange cradles the child's medial arch, providing long-term comfort and reducing fatigue by redistributing weight and pressure evenly.

Junior Formthotics are available in 4 sizes to suit children from about 3 to 9 years of age. They are suitable for use where careful management of the hypermobile or excessively pronated foot or encouragement of normal development and foot function is required in treatment of your paediatric patients. Each pair of Junior Formthotics contains a colouring book.

Sizes				
Sizes	J1	J2	J3	J4
UK	8-9½	10-11½	12-13½	1-2
EUR	25-27½	28-9½	30-32½	33-34½
US	9-10½	11-12½	13-1½	2-3½
Foot Length	150-165mm	170-180mm	185-195mm	200-210mm
Approx Age (girls)	3-4	4½-5½	6-7½	8-9
Approx Age (boys)	3-3½	4-5	5½-7	7½-8

- 010447J1 J1
- 010447J2 J2
- 010447J3 J3
- 010447J4 J4

2 Junior Formthotics Starter Kit

The junior starter kit contains:

- 4 Pairs of each size of Junior Formthotics
- A display stand
- Poster and leaflets

010472

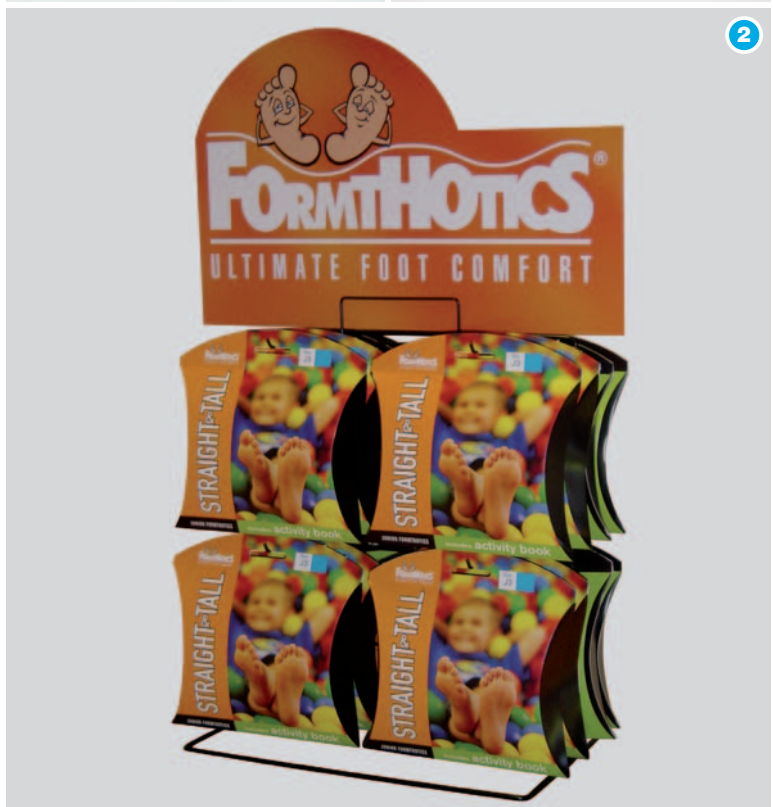

1

Tumble Forms 2[®]
With Anti-Microbial Protection



ASCENDERS CAN BE USED TO ADJUST HEIGHT OF MODULES

PRONE NET SWING

DESIGNED FOR A WIDE RANGE OF THERAPEUTIC ACTIVITIES

MAT

NOT SUITABLE FOR OUTDOOR USE



1 Tumble Forms 2[™] Deluxe Vestibulator[™] II System Sammons Preston

The free standing Vestibulator System offers your facility all the benefits of a ceiling suspension system without the installation costs and concerns. It has the capacity to accommodate a wide range of therapy modules for vestibular, neurodevelopmental, and sensory integration therapy. When used with various accessories, the Deluxe Vestibulator System provides vertical stimulation and direct flexion, linear acceleration, rotational experiences, and complete range of motion exercises. It also incorporates a 360° vertical rotation system for a smooth, unrestricted range of movement to create vertical and rotational stimulation at the same time. Height adjustment assembly allows quick changes to the proper position. The mechanism can be fixed in a stable position or set for swinging. Accessory pieces are lightweight and easy to manoeuvre. Legs are removable for portability and storage.

Deluxe Vestibulator II System Includes

Frame, net swing with positioning seat, flexidisk, prone net swing, mat, platform swing, roll swing, rope with ascenders.

2784 Deluxe Vestibulator Set
Total Weight of Set, 91kg (14½st)

Maximum user weight

227 Kg **35½ st**



Accessories Available Separately

- 2784F** Frame with Rope and Ascenders
Height 2320mm (91")
- 2772P** Platform Swing - 380 x 760mm (15 x 30")
- 2772D** Flexidisk - Diameter 514mm
- 2772H** Roll Swing
Diameter 360mm (14"). Length 1220mm (48").
- 2772N** Prone Net Swing
- 2772S** Net Swing with Positioning Seat
- 2772M** Mat - 1520 x 2130mm (60 x 84")
Thickness 50mm (2")
- 2772RA** Rope with Ascender - Not Illustrated
- 556823** Horse Roll - Diameter 914mm (36")
- 556824** Free Swing
- 556825** Platform Swing - Length 1524mm (5ft)



FLEXIDISK



PLATFORM SWING



ROLL SWING



NET SWING AND POSITIONING SEAT

SDD UK SAME DAY DESPATCH
Delivered from stock. Please contact Customer Services for more information.

Tumble Forms 2™

With Anti-Microbial Protection

1 Tumble Forms 2™ Tortoise Shell™ Therapy System Sammons Preston

Use this colourful, moulded polyethylene shell for vestibular therapy and sensory integration. Ideal for children 0 to 5 years of age in early intervention programme, either individually or in a group. Use the lid as a recessed base to prevent the shell from rocking, or on top as a flat surface for vestibular therapy. Shell is portable, easily cleaned and measures 860mm (34") wide x 460mm (18") high. The Deluxe Tortoise Shell Therapy System includes snug fitting net filled with 51mm (2") Bubble Balls for buoyancy and sensory feedback. Net fits on shell; balls remove easily for cleaning and storage.

- 2885** Shell with Lid
- 2886** Deluxe Tortoise Shell Therapy System includes Shell with Lid and Net with Balls
- 2885B** Replacement Net with Balls
- 2885C** Shell with Lid, Net with Balls and Suspension Kit



2 Tumble Forms 2™ Tortoise Shell™ Suspension Kit Sammons Preston

Suspends the shell from the Deluxe Vestibulator II, III or IV Therapy System. Kit includes all ropes and hooks necessary to attach the shell to the swing arm of the Deluxe Vestibulator II, III or IV Therapy Systems.

- 2885R** Tortoise Shell Suspension Kit

Maximum user weight **36 kg** **5 1/2 st**



3 Tumble Forms 2™ Deluxe Turtle™ Therapy System Sammons Preston

Ideal for any clinical program, the Deluxe Turtle is a complete therapy system designed for vestibular stimulation and sensory integration therapy.

System Includes

- Rocking Turtle Dome
- Padded Scooter
- T-Stool Attachment
- Net Swing with Rope and Ascender
- Therapy Record Booklet
- Complete Turtle Methods Manual

- 2882** Deluxe Turtle Therapy System



4 Tumble Forms 2™ Turtle Therapy System Sammons Preston

This system is an economical package designed for the travelling therapist. It includes everything in the Deluxe Turtle, except the Net with Rope and Ascender.

- 2880** Turtle

5 Tumble Forms 2™ T-Stool/Scooter Sammons Preston

Can be ordered separately. It features a padded Turtle System scooter and height adjustable T-Stool leg attachment. The T-Stool/Scooter is perfect for balancing and extension activities.

- 2883S** T-Stool/Scooter



SPARES
Spares are available for these products, making them suitable for refurbishment. For full spares listing, please see pages 1353 to 1360.



1 Thera-Band

I recently delivered a Healthy Schools Day in a local Primary School, where I performed a group upper limb strengthening session with a class of ten-year-old children using Thera-Band. All of the children thoroughly enjoyed using the Thera-Band and were hugely impressed with the fact that all of the major muscle groups can be easily exercised with just one piece of equipment.

Mark Leighton – Physiotherapist, North East Clinic



1 Thera-Band "Having Fun – Getting Fit" Kit

"Having Fun - Getting Fit" helps promote physical activity by offering pre-designed physical education programs for primary schools. The program is ideal for children between the ages of 3 and 10. The lessons in the program target developing children's musculoskeletal system. They offer a range of exercises that can be adapted according to the varying ages and ability levels of the children. The kit includes:

- Lesson Planner Book (12 Lessons)
- 1 x Cube/Dice
- Box of Stickers
- 1 Set of Flash Cards

Thera-Band Resistance Bands

- 6 Thera-Band Green Bands (2.5 m)
- 6 Thera-Band Blue Bands (2.5 m)

- 4 Thera-Band Red Bands (2.5 m)
- 4 Thera-Band Yellow Bands (2.5 m)
- 10 Thera-Band Red Bands (1.5 m)
- 10 Thera-Band Yellow Bands (1.5 m)

Thera-Band Exercise Balls

- 6 Yellow 45 cm
- 4 Red 55 cm

Thera-Band Stability Trainer

- 2 green (light)
- 6 blue (heavy)

Thera-Band Soft Weights

- 2 Tan 1.1 lb. / 0.5 kg
- 3 Yellow 2.2 lb. / 1.0 kg
- 1 Red 3.3 lb. / 1.5 kg

09 142 3540



2 Airex™ Balance Pad Elite

The Balance Pad Elite is designed to help co-ordinate and improve body movements and balance skills. The new waffle pattern on the top and underside of the pad, makes it non-slip.

Length	Width	Thickness	Colour	Weight
50cm	41cm	6cm	Blue	0.7kg

09 112 5566



3 Airex™ Balance Beam

The Balance Beam has multi functional therapy applications. Warm and comfortable to touch, the balance beam provides a base for an individual to work toe-to-toe improving lower and upper body stabilisation and co-ordination. Easy to clean, impervious to water, with a sanitised anti bacterial finish. Height 6cm. Length 160cm. Width 24cm. Weight 0.9kg. Applications: Physiotherapy, rehabilitation, neurology, elderly, orthopaedics, group training, and schools.

AA90002



1 Tumble Forms 2™ Barrel Crawl/Roll Sammons Preston

By gently rocking the barrel, the therapist can produce a rhythmic movement experience for the child. In time, the child can learn to shift his or her weight in order to roll the barrel. Inside diameter 305mm (12"), outside is 560mm (22").

4163B

2 Rainbow Barrel

Children love the sensation of rolling on their stomach or back. The Rainbow Barrel promotes spatial awareness and helps build confidence. In addition to crawling activities the barrel can be gently rocked with the child inside for vestibular motion. The tough, colourful PVC coated nylon covering is simple and easy to clean.

Dimensions: Length 1220mm (48"). Diameter 965mm (38").

AA75903

3 Tumble Forms 2™ Balance Beam Sammons Preston

This 6ft reversible balance beam is covered with durable, sturdy Tumble Forms 2 non-slip surface. The balance beam can be used to improve body stabilisation, co-ordination and posture. May be positioned so width is 75mm (3") or 150mm (6"). The beam is 180mm (7") high. Weight 12.7kg.

4807E

Maximum user weight



4 Tumble Forms 2™ Rocker Balance Board Sammons Preston

Provides vestibular stimulation, promotes balance and facilitates co-ordination. Made of solid wood covered with durable non-slip Tumble Forms 2 coating.

Measures: 483mm (19") square x 102mm (4") high.

819401

Maximum user weight



5 Vestibular Board

An extra large support surface makes vestibulator training easier and safer. The Vestibulator Board's broad surface accommodates larger clients and a wider variety of balance positions. Rocking the body on this board stimulates balance control and vestibular responses.

Heavy plywood top has a grey, removable, washable, nylon/tricot fabric cover and measures 1525mm (60") in length by 762mm (30") in width. Legs fold inward for easy storage.

4813D

Maximum user weight



6 Tumble Forms 2™ Soft-Top Rocker Balance Sammons Preston

The foam cushioned top is non-slip and non-abrasive, providing sure footing during rocker/balance exercises. Unit wipes clean and will not mark floors or walls. Recessed sides protect fingers against pinching. Dimensions: 455 x 610 x 152mm (18 x 24 x 6").

4811

Maximum user weight



STIMULATES BALANCE CONTROL, RUBBER SUCTION FEET ANCHOR BOARD TO COUNTER





1 Tactile Discs
 These tactile discs are designed to challenge a child's sense of touch and recognition. Each set of ten discs contains five small and five large, different structured discs, which are colour co-ordinated and are made from soft rubber. The discs offer numerous playing possibilities ranging from fundamental sensing of structures to blindfold games based on memory and recognition.
 Small Discs: 110mm diameter Large Discs: 210mm diameter
AA75615

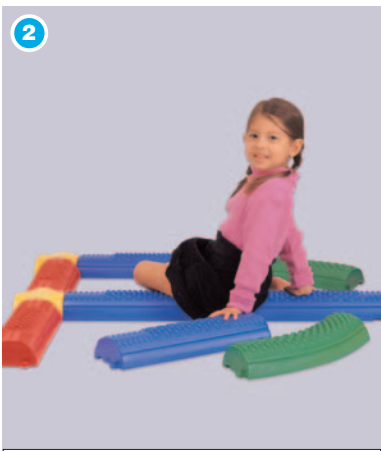

MASTER SET



CURVED SENSORY BALANCE BEAMS

2 Sensory Balance Beams
 These tactile balance beams are designed to help develop balance and co-ordination as well as providing tactile stimulation and sensory experience for children.
Master Set
 A set of eight straight and eight curved balance beams with four square, connecting blocks that can be used to make the beams multi-directional. Assorted colours.
AA75611
Curved Sensory Balance Beams
 A set of eight curved pieces, which can be used to form a circle, 'S' shape, curved path or can be combined with straight sections to create almost any shape you desire. Each section is 490mm (19") long x 135mm (5 1/4") wide x 70mm (2 3/4") high. Assorted colours.
AA75612
Straight Sensory Balance Beams
 Set of eight straight pieces, which can be used to form a long straight path, shorter parallel paths or can be combined with curved pieces to create numerous shapes. Each section is 490mm (19") long x 135mm (5 1/4") wide x 70mm (2 3/4") high. Assorted colours.
AA75613



STRAIGHT SENSORY BALANCE BEAMS

3 Paediatric Steps
 These steps are brightly coloured to brighten any paediatric clinic and aid compliance. On one side there are four steps with a depth of 115mm (5 1/2") and on the other there are three steps with a depth of 150mm (5 7/8"). The handrails adjust from 330mm (13") to 750mm (25 1/2"). Length 1120cm. Width 940mm (37").
AA9567P
 Maximum user weight **64 kg** **10 st**



4 Nesting Steps
 This set of wooden stools is ideal for body mechanics and posture training when standing, to use at a desk or during seated mat activities. Non slip rubber surfaces prevents slipping. Nest for storage. Can be wiped clean. Set of four includes the following sizes:

Height	Width	Depth
200mm	500mm	450mm
150mm	450mm	400mm
100mm	400mm	350mm
50mm	350mm	300mm

AA9552

INFORMATION
 The maximum user weight refers to the steps only.
 The hand rails are not fully weight bearing and are for support only.

MADE TO ORDER
 This item is made to order and, therefore, is not refundable.

DELIVERY
 Delivery is approximately 4 weeks. Please contact Customer Services for more information.

1 Sens'o'Roll

This orange double physio roll has a textured bumpy surface to provide additional sensory and tactile stimulation. The double ball provides additional stability making it ideal for children or adults who have problems with balance and co-ordination. Can be used for postural relaxation or developing co-ordination and balance. Must be inflated. Dimensions: 900 x 500mm.

AA75610

Maximum user weight

**2 Gymnic™ Classic**

These exercise balls are used to improve flexibility, co-ordination and balance, also to strengthen and tone abdominals, trunk muscles, arms and legs. These inflatable vinyl balls provide excellent therapy for perceptual motor training activity, especially for children with abnormal reflex patterns or for general exercises and group activities. Seamless construction withstands rugged use by active children and adults. Distance from shoulder to finger tip equals diameter of ball required.

	Diameter	Colour
AA9080A	45cm	Yellow
AA9080B	55cm	Red
AA9080C	65cm	Blue
AA9080D	75cm	Yellow
AA9080E	85cm	Red
AA9080F	95cm	Blue
AA9080G	120cm	Red

Maximum user weight

**3 Tumble Forms 2™ Neuro Balls**

Sammons Preston

Training balls for developing vestibular response and balance, and for exercise. The smallest ball is designed for rolling, pushing, throwing and kicking; the largest has a rigid core to prevent "bottoming out".

	Diameter
2769L	560mm (22")
2769M	405mm (16")
2769S	280mm (11")

4 Faster Blaster

Handy 175mm (7") long hand pump to inflate balls in a matter of seconds. Compact and lightweight, making it completely portable.

AA9055

5 Physio-Rolls

People unable to tolerate traditional ball therapy can be successful with Physio-Rolls. Motion is limited to forward and back and side to side, providing greater stability than a round ball.

Rated to 300kg. The therapist can sit on the ball and support the patients movements. Suitable for all ages, particularly good for children. Five sizes available.

	Diameter	Colour
AA9081A	300mm	Blue
AA9081B	400mm	Red
AA9081C	550mm	Yellow
AA9081D	700mm	Blue
AA9081E	850mm	Red

6 Rody

Rody is a jumping horse for therapy and play. Enjoyment and active play are assured with this fun inflatable. It can be inflated according to the size and age of the child and comes complete with one valve and two plugs.

Maximum circumference at the saddle is 72cm. Weight 1.6kg

AA9808Y	Yellow
AA9808R	Red





1 Slo-Mo Bump Balls

Made from a foam like material, these balls are soft, yet durable. They can be inflated by breath alone. No need for a pump. Can be inflated to any size between 180mm and 255mm. Comes as a set of six balls, one of each colour - Red, Yellow, Blue, Green, Violet and Orange.

AC1340

2 Spordas Success Ball

Success balls are ideal for younger children. They are easy to catch and hold because they are filled with foam pellets, which conform to the child's hand. The balls are also easy to track as air entering through the mesh panels provides a parachute-like slowdown. The balls do not hurt on impact.

The balls are 150mm in diameter and come in a set of six balls, one of each colour – Red, Yellow, Blue, Green, Orange and Violet.

AC1339

3 Access Switch

The Access switch comes with a clear screw on cover that screws onto the switch preventing the cover from coming loose or falling off. The screw on cap becomes an integral part of the switch allowing symbols or objects up to 2mm thick to be placed securely under the switch cap without fear of them popping out. Available in small (26mm diameter by 11mm high) and medium (65mm diameter x 23mm high). Both switches have a 1.4m long cable fitted with a standard 3.5mm jack plug.

	Diameter	Colour
AA75628B	26mm	Blue
AA75628F	26mm	Red
AA75628G	26mm	Green
AA75628I	26mm	Yellow
AA75629B	65mm	Blue

4 Soft Frame Bubble Mirror

Provides visual perceptual experiences, reflective learning, and aids sensory-motor integration. 230mm diameter bubbles provide multi-duplication of images that change in shape and size. The 860mm (34") square vinyl foam and acrylic mirror can sit on a table-top or mount on a wall. Mounting hardware not included. Shatterproof.

3623 Soft Frame Bubble Mirror
09 120 3991 Concave Bubble Mirror

5 Bubble Column

Equipped with a socket to enable switch operation, this beautiful bubble column is ideal for visual tracking and concentration skills. Operate the switch to see the bubbles and watch as the colour of the column slowly changes from red to green to yellow to blue. The bubbles rise and the column soothingly vibrates for tactile feedback. Height 813mm (32"), diameter 102mm (4").

AA75630



Soft Frame Bubble Mirror



Concave Bubble Mirror



1 Multi-Task Dressing Vest

Ideal for practicing dressing skills such as buttoning, zipping and snapping. For children or adults with compromised fine motor skills, apraxia, hemiplegia and cognitive deficits. Very durable cotton duck with 76mm (3") elastic on both sides for room. Hand or machine wash in cold water. Lay flat to dry. Available in four sizes. Latex on elastic side straps only.

Note: This product contains natural rubber latex.

Item	Description	Length	Width
929000	Child Vest	445mm	356mm
929001	Small Adult Vest	521mm	445mm
929002	Medium Adult Vest	584mm	533mm
929003	Large Adult Vest	635mm	584mm

2 Dressing Cube

A colourful cube, excellent for teaching children to improve their hand-eye co-ordination.

Includes six different skills - children can practice how to:

- Button
- Zip
- Buckle
- Snap
- Lace
- Hook & loop

Dimensions: 203 x 203 x 203mm (8 x 8 x 8")

Made of 100% cotton. Machine washable, dryer safe.

For ages 2 to 5.

4948

3 Parachute

Whether standing or sitting, groups of children or adults can enjoy the visually stimulating activity of raising or lowering this large parachute. Used to improve upper extremity range of movement, trunk strength and cardiovascular fitness. Perfect for co-operative activities. Made of multi-coloured, durable nylon with evenly spaced handles.

Soft balls can be bounced on the top having the participants attempt to keep them on the parachute. Available in three sizes.

928131 3.6m (12') Diameter

8152 1.83m (6') Diameter

4 Foam Balls

Safe and lightweight, 180mm foam balls come in packs of six. Excellent for gross motor skills and hand-eye co-ordination.

8218



ONE SIDE OF VEST HAS BUTTONS, THE OTHER SIDE HAS SNAPS AND A ZIPPER

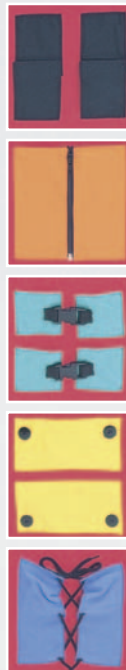

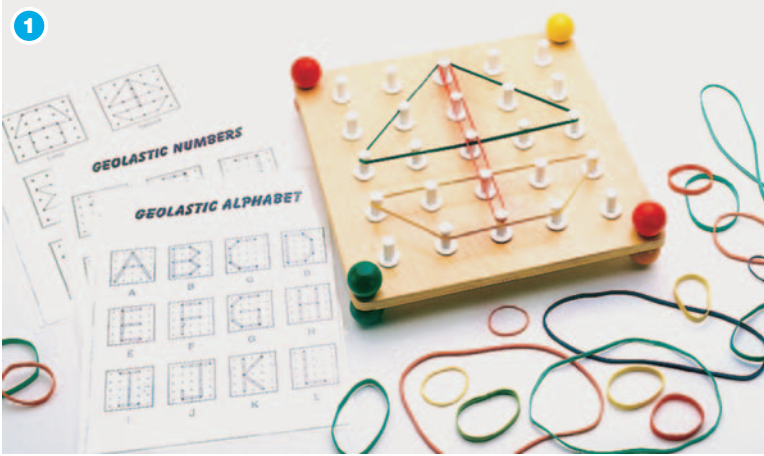

1 Geo-Lastic Art

This kit uses colourful rubber bands of various sizes to create geometric designs. The complexity of the pattern can be varied to help patients improve cognitive skills. Ideal tool to encourage tasks that cross midline. Kit includes wooden board, 15 smooth plastic pegs, soft and safe elastic bands and pattern book. Wooden base. Dimensions: 300 x 300 x 50mm (12 x 12 x 2"). **924970**

2 Complex Form Board

Rolyan

This complex board has 12 shapes for evaluation and training in form constancy, position in space, shape recognition and sequencing as well as teaching compensatory techniques for loss of visual field. Dimensions 620 x 410 x 13mm (24 1/2 x 16 x 1/2"). Shapes are 22mm (8 1/2") high. Colour of shapes may vary. **A4161** Set

3 Pegboards and Pegs

To improve hand-eye co-ordination, fine motor skills and cognitive skills. The tall, slim unbreakable pegs are easy to grasp and place. Each peg fits smoothly into the crepe rubber pegboard or into the top of another peg.

- 836701** 50 Tall Stacker Pegs
- 836702** 100 Tall Stacker Pegs
- 836703** Giant Pegboard (100 holes) 432mm
- 836704** Large Pegboard (100 holes) 292mm
- 836705** Big Little Pegboard (25 holes) 203mm

4 Pegboard with Round Pegs

Basic 30 hole pegboard that can be used easily regardless of age and user level. Consists of a 305 x 255mm (12 x 10") wooden board and 30 pegs in five colours. **8181**

5 Sensory Motor Kit

12 different tactile experiences all in one bag. Take it with you wherever you go. Smaller items help develop fine motor skills, while larger items help develop gross motor skills. Includes rings, tactile balls in various sizes and styles, water mat, koosh balls, and tangle. Great for kids of all ages! **09 116 3898**

1 Stereognosis Kit

Rolyan

The kit consists of 17 common items and matching cards for evaluation of stereognosis. The 80 x 130mm cards are laminated for long term use. Each card has a drawing and the name of the item in English (and Spanish). On the back of each card is the name of the item for use by the evaluator. This kit can be used in conjunction with the Rolyan Sensory Testing Shield.

A4542

2 Sensory Testing Shield

Rolyan

A moulded plastic shield that incorporates many features to assure totally occluded vision and patient comfort during administration of a test. The moulded ridge holds the cards for stereognosis and other types of testing. The legs are removable for convenient storage. All of its parts can be cleaned with a disinfectant.

A4541

3 Cognitoys Set

Helps cognitively and physically challenged children and adults improve reach, range of motion, midline crossing, co-ordination and upper extremity strength and endurance through graded, repetitive exercise. 16 brightly coloured wooden shapes and detachable wooden dowels in four heights up to 851mm (33 $\frac{1}{2}$ "") on base can be used for a variety of exercises and to promote colour and shape recognition. Exercises can be performed standing, sitting or from a wheelchair. Sturdy, wooden base measures 305 x 889 x 19mm (12 x 35 x $\frac{3}{4}$ "").

5152





1 LOTCA™ II Battery

Revised second edition of this standardised cognitive assessment battery. The test, which was designed especially for therapists by the Lowenstein O.T. Department, Israel, includes standardised testing procedures. Consists of four major areas and 20 subtests including orientation, perception, visual motor organisation and thinking operations. Can be used for evaluation of stroke patients, traumatic brain injury patients and patients with other neurological impairments. Can also be used with psychiatric or geriatric patients to determine cognitive dysfunction. Includes directions and test materials in a portable plastic case.

4910 Set

2 PDMS-2 (Peabody Development Motor Scales - 2nd Edition)

The second edition of this evaluation tool has been improved based on research and feedback from users. This package provides both in-depth assessment and training or remediation of gross and fine motor skills for children from birth through to six years. Six subtests (reflexes, stationary, locomotion, object manipulation, grasping and visual motor integration) reliably measure interrelated motor abilities and have been standardised on 2003 children. Allows users to determine a child's Gross Motor Quotient, Fine Motor Quotient and Total Motor Quotient. The new Profile/Summary Form records a child's scores - age equivalents, raw scores, percentiles, standard scores - and graphically displays the child's performance to determine strengths, weakness and progress. Kit includes 25 new Examiner Record Booklets, Illustrated Guide for Administering and Scoring, 25 Profile/Summary Forms, the Peabody Motor Activities Program Manual, the new black and white Peabody Motor Development Chart, manipulatives, and a sturdy storage box.

- 804302 PDMS-2 Complete Kit
- 804303 PDMS-2 Examiner Record Booklet (25)
- 804304 PDMS-2 Profile/Summary Form (25)



3 Peabody Motor Development Chart

Provides the examiner with a convenient reference for the motor skills measured by the PDMS-2 and the ages at which 50% of the normative sample performed the skill. Each of the subtests is represented, along with numerous illustrations of children demonstrating the behaviours described in the text. Measures 96.5 x 66cm. Latex free.

927035

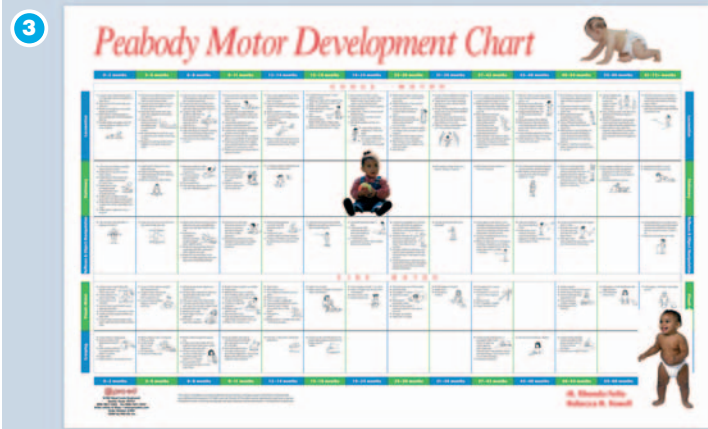

4 DOTCA-CH™ Battery

Developed on the basis of the LOTCA™ battery, DOTCA-Ch provides a measure of cognitive assessment and learning potential for children ages 6-12 with special needs. It consists of 22 sub-tests in 5 cognitive areas: Orientation, Spatial Perception, Praxis, Visuomotor Construction and Thinking Operations. For each sub-test there is an option of a structured 5-step mediation. Measures of short-term memory and time of performance are included in the visuomotor organisation area. The goals of the assessment are to identify the strengths and deficits of the child in the different cognitive areas and measure learning potential, as well as to recognise the child's thinking strategies utilising dynamic procedures.

Data for typical children ages 6 to 12 years, groups of children with learning disabilities and brain injury was collected to establish the standardisation, reliability and validity properties of the test.

Administration time is approximately 1 1/2 hours. It is possible to administer the test in more than one session.

09 116 3658



1 Tar-Grip™ Floor Target Game

The Velcro hook target game allows the development of gross motor skills and hand-eye co-ordination. The target grips the special loop balls when they come into contact with it. Non-slip rubber feet keep the target in place. Includes four balls. Dimensions: 610mm (24") square.

8363

2 Giant Tumble Tower

A garden version of one of the most popular indoor games. Build a tower over four feet tall. A game of strategy and dexterity, providing hours of fun for two players or teams of players.

AC1154

3 Noughts and Crosses

Another classic game that promotes creative play and cognitive skills. Large easy to hold shapes for those with poor grasp. Wooden board is 292mm (11½") square. Pieces are 63mm (2½") high.

8188

4 Large Print Scrabble

Traditional Scrabble game but with a clearer board and larger letter tiles to aid recognition. Developed in association with the RNIB. Tile size: 25 x 25 x 5mm (1 x 1 x ¼").

AC1480

5 Shape Dominoes

A set of 21 plywood dominoes with raised, colour-coded wooden shapes. Ideal for shape and colour matching activities as well as traditional domino games.

AC1481

6 Bowling Set

Both ambulatory and wheelchair-bound children over 3 years in age and adults will enjoy the game of bowling while improving gross motor skills, co-ordination and hand-eye co-ordination. Made of soft, dense foam, this set includes six 180mm (7") pins, one bowling ball and a placement mat. Can be used both indoors and outdoors. Wipes clean with a damp cloth. Colours may vary.

920210

7 Mega 4 in a Line

A classic game in a giant size! Lightweight yet tough construction, it is suitable for indoor and outdoor use. Size: 1340 x 570 x 1080mm (52¾ x 22½ x 42½").

AC1485

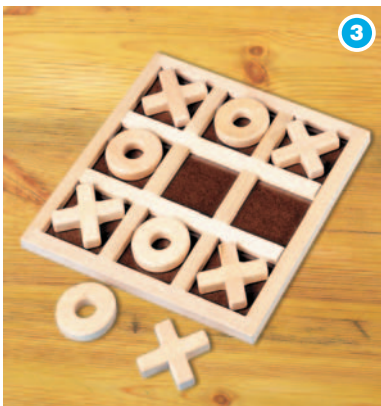



1 Paediatric Feeding Evaluation Kit Homecraft

Specifically designed for paediatrics, this kit contains a variety of special eating utensils selected to help explore and solve the problems that delay or prevent self feeding. The 30 items included represent most areas of need. The kit is packed in a handy carry case for convenient use and includes:

- AA5575 Junior Caring Cutlery Knife
- AA5576 Junior Caring Cutlery Fork
- AA5550 Lightweight Foam Handle Knife
- AA5556L Lightweight Foam Handle Left Fork
- AA5557R Lightweight Foam Handle Right Spoon
- AA5597Y Nelson Knife
- AA5595 Splayed Fork with Slim Handle
- 124001 Paediatric Spoon - Red
- 124008 Paediatric Built Up Spoon - Blue
- 1371 Paediatric Utensil Holder
- 109003 Flexible Tablespoon
- AA75504 Paediatric Easigrip Cutlery - 1 Set
- AA75505 Paediatric Easigrip Cutlery (Built Up)
- 1002 Child's Feeding Spoon
- 110101 Adjustable Weighted Teaspoon
- 920359 Rocking T Knife
- AA6110 Closed Cell Foam Tubing - Paed Pack
- AA5662W Incurve Plate Surround
- 1548 Suction Scooper Bowl
- AA5610 Manoy Plate
- AA75506 Doidy Cup
- AA5720 Two Handed Mug
- AA5710W Caring Mug - Bulk Pack
- AA5723 Non Spill Cup
- 1145 Nosey Cutout Cup - 236ml
- AA5759 Teapot Feeder
- AA6812F Dycem Anchorpad - 190mm Diameter - Red
- AA6830B Dycem Grippistrip - 2m
- A684403 Partitioned Scoop Dish with Lid
- AA75503 Paediatric Feeding Evaluation Kit**

2 Suction Scooper Bowl

This 110mm (4 1/2") dish has a suction base attached. The curved rim guides food onto the spoon whilst the slip-resistant base helps keep the bowl firmly in place. Once the suction ring has been removed, the bowl is dishwasher safe. Colours may vary.

1548



3 Closed Cell Foam Tubing

Use for building up tool and utensil handles to give greater control to people who lack co-ordination, strength or gripping ability. Tubing has a slip resistant outer layer and is dishwasher safe. Colour assortment, bright for paediatrics, includes two bright Yellow, two bright Orange and two bright Blue. The pieces can be cut to the required length. Length 300mm (12"). Inside diameter 6mm (1/4") to 20mm (4/5"). Outside diameter 25mm (1") to 29mm (1 1/8").

AA6110

DISHWASHER SAFE
This product is suitable for use in a dishwasher.

1 Junior Caring Cutlery

A range of knife, fork and spoon designed primarily for children. With small utensil heads, these are easy to clean and dishwasher safe. Stainless steel cutlery. Length of handle 102mm (4"). The knife and spoon weigh 24g. The fork weighs 22g.

- AA5575** Knife
- AA5576** Fork
- AA5577** Spoon

2 Maroon Spoon

A narrow, shallow bowl makes it ideal for feeding therapy. Tough and break resistant (do not use with clients with severe bite reflex). Dishwasher safe, no heated drying. Comes in packs of 10.

- 920273** Small 146 x 25mm
- 920274** Large 152 x 32mm



3 Paediatric Weighted Utensils

Child size utensils that are weighted to stabilise the hand. Shaped red plastic vinyl handles. Stainless steel utensils. Handles are 22mm in diameter and 82mm long. Each weighs approximately 110g. Dishwasher safe up to 80°C (180°F).

- 110201** Fork
- 110202** Teaspoon



4 Etac Feeding Cutlery

The feeding cutlery has soft round edges for a comfortable feel in the mouth, and a shape that makes it easy to give food to people who cannot open their mouths very much. The long handle means the person being fed can also hold the cutlery. The handle gives the feeder a comfortable grip and good balance. The spoon and fork are 220mm long and the small spoon is 200mm long. Dishwasher safe.

- 09 116 1967** Feeding Spoon Small
- 09 116 1959** Feeding Spoon Large
- 09 116 1975** Feeding Fork



5 Etac Feed Angled Spoon

The angled spoons make it easier to move the hand from plate to mouth, and are suitable for children and adults with small hands. The bowl is adjustable, and the handle has a combined support and stop peg. The spoon is suitable for a child's or small hand allowing the spoon to be held near the bowl head. The strap offers additional support for children with poor gripping ability. Total length 160mm. Weight 40g. Dishwasher safe.

- 09 116 1983** Right Handed Spoon
- 09 116 1991** Left Handed Spoon



DISHWASHER SAFE
This product is suitable for use in a dishwasher.

RETAIL PACKAGED
This product is supplied in retail packaging.



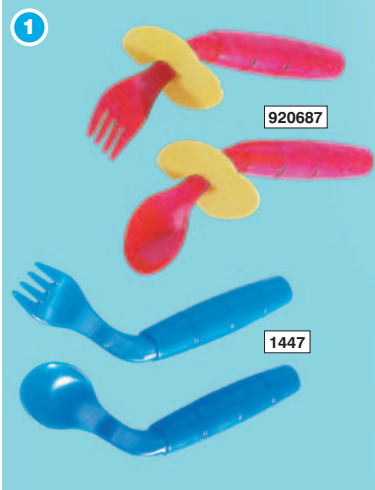

1 EasieEaters™ Curved Utensils

Lightweight and easy to grip plastic utensils that are angled to promote greater success with hand to mouth feeding. Built up handles make them easier to hold and a safety shield prevents utensils from entering the mouth too deeply. Set includes fork and spoon. Dishwasher safe, colours may vary. Handle 76mm (3") long.

- 1447** Right Handed Utensils
- 144701** Left Handed Utensils
- 920686** Right Handed with Shield
- 920687** Left Handed with Shield



2 Flexible Paediatric Cutlery

These versatile utensils wrap easily around the hand and/or wrist to secure in the position required. The foam handle is 19mm (3/4") in diameter and may be customised to fit a user's grip. Includes a 250mm (10") Velcro brand hook and loop strap that further secures the utensil. 250mm (10") long. Weight 50g. Handwash with warm, soapy water.

- 109501** Flexible Fork
- 109502** Flexible Spoon

3 Paediatric Easigrip Cutlery

Curved spoons and forks give children a more natural grip on the handles. Moulded of sturdy plastic. Two options available, two sets (two forks, two spoons) in one package or one fork and one spoon with built up handles in the other.

- AA75504** Two Sets
- AA75505** Built Up Set

4 Paediatric Steady Spoon

Uniquely designed spoon allows those who could not ordinarily feed themselves to achieve independence. Five moving parts and counter weights keep the spoon bowl level no matter what the child's arm position or level of tremor preventing food spillage. A hook and loop strap on a built-up handle eliminates the need for a strong grasp. Ideal for users with Cerebral Palsy, head injury, Muscular Dystrophy and any type of tremor or lack of co-ordination. The spoon's 142g (5oz.) weight gives added proprioceptive input for children with PDD and SI problems. Black hook and loop strap included. The Bowl is a youth teaspoon size. Dishwasher safe up to 104°C (220°F). Latex free.

Dimensions

- Handle: 114mm (4 1/2") long x 29mm (1 1/8") in diameter
- Handle and bowl: 197mm (7 1/2") long
- Strap: 102mm (4") long

AA75502



5 Paediatric Plastic Base Utensil Holder

This half-cone shaped plastic base utensil holder angles the utensil away from the palm to make eating easier. The holder is made of washable nylon and plastic. Utensil not included. Latex free.

09 100 1452



DISHWASHER SAFE
This product is suitable for use in a dishwasher.

1 Caring Mug Homecraft

This mug has a wide stable base with two large contoured and angled handles, which enables it to be held in the correct position for drinking. The lid has a well designed spout, and matches the Caring Cutlery range. It is useful for those with tremor or who cannot sit upright. The mug is suitable for use in a microwave, but not recommended for dishwashers. Capacity 300ml (11fl.oz). Weight 176g.

		Aperture Size
AA5710Y	Retail Packed	Standard
AA5710W	Non Retail	Standard
09 116 5422	Non Retail	Large
09 116 5430	Spare Lid	Large
AA571001	Spare Lid	Standard



2 Caring Mug with Adjustable Handles Homecraft

This variation of the Caring Mug can be customised to meet an individuals needs. One handle is adjustable and can be positioned anywhere around the mug to give the most comfortable grip for the user. The locking device on the handles is simple and easy to use allowing the handle position to be changed quickly and easily. Supplied with either a small lid for liquids, or a lid with a large aperture for thickened liquids. Suitable for use in a microwave and dishwasher. Capacity 300ml. Weight 176g.

		Aperture Size
09 116 5406	Retail Packed	Small
09 116 5398	Non Retail	Small
09 116 5414	Non Retail	Large
AA571001	Spare Lid	Small
09 116 5430	Spare Lid	Large



EASY TO ADJUST HANDLE



3 Sure Grip Mug

This feeding cup has an angled spout to facilitate ease of use. Grooves in the cup ensure a better grip and the unique valve enables flow control and no spills. Also available in a variety of colours so the cups can be used to differentiate between users or contents, or simply to add interest. Weight 75g. Capacity 200ml (7fl.oz). Microwave and dishwasher safe up to 130°C.

AA5723	Clear
AA5723B	Blue
AA5723I	Yellow
AA5723E	Green
AA5723F	Pink

4 Cup with Temperature Controlled Lid

This version of the Sure Grip Mug above has a lid that changes colour when the contents are hotter than body temperature. If liquids hotter than 37¹/₂°C (96°F) are put into the beaker the lid will change colour from blue to pink, alerting the user to be careful when drinking. The lid is safe and easy to use and can also be used with a straw. Do not leave lid in direct sunlight.

AA5769



5 Kennedy™ Cup

This spill proof cup is perfect when sitting or reclining. The easy to grip handle can be picked up by weaker hands and is suitable for right or left handed persons. The lid screws on tightly to prevent leaks and accepts any standard disposable straw. This lightweight, durable cup holds 200ml (7fl.oz) of warm or cold liquid. Dishwasher safe to 80°C (180°F).

1249

6 Pat Saunders Straws

These straws have one-way valves which stay filled with fluid, even after removing the straw from a user's lips. This feature eliminates the possibility of sucking in too much air while drinking. The clip-on straw hooks onto the side of a glass or cup to prevent the straw from falling out. Each package includes one 254mm (10") and one 178mm (7") straw.

1110





1 Doidy Cup

This unique training cup is specially designed to encourage babies to drink from a rim rather than a spout. Babies as young as 6 months find the two handled cup easy to hold and to drink from as the natural action used is the same as in breast feeding. Helps prevent tooth decay and speech problems associated with weaning from the bottle. Colours may vary.

AA75506 192ml (6½ fl.oz) Capacity

2 Flexi Cups

These flexible cups with cut outs can be gently squeezed to change the shape of the cup lid. Liquid is visible through the plastic to aid with feeding. The green cup is stiffer and designed to be used independently. Dishwasher safe and latex free.

920270 Pink Flexi Cups 30ml (1 fl.oz.) - Set of 5

920271 Blue Flexi Cups 59ml (2 fl.oz.) - Set of 5

920272 Green Flexi Cups 207ml (7 fl.oz.) - Set of 5



3 Cup with Built-in Straw

These cups are ideal for children and adults who need to drink using a straw. The built-in straw eliminates the need to buy and keep track of additional straws as well as preventing straw movement to aid drinking. To prevent air ingestion, the straw has access to liquid at the bottom of the cup.

555671 Small, green cup 384ml (13 fl.oz)

555672 Large, yellow cup 473ml (16 fl.oz)

4 Provale™ Cup

Created to preserve the dignity of those who suffer from dysphagia or disorders associated with difficulty swallowing. The Provale Cup can be filled at the beginning of the meal and the diner can drink at will, on their own. The cup delivers a measured amount of liquid (5ml or 10ml) to the drinker to prevent choking. The cup also allows cleanup to be limited to one piece of dinnerware rather than the several parts of other feeders. Optional one or two easy-grip handle or no handle design.

551845 5ml Dispenser Blue

551846 10ml Dispenser Brown



5 Waterproof Bioprene Bib

This large bib is made of medical grade neoprene called "Bioprene" and has good shoulder and chest coverage. The Bioprene material is treated with an active antimicrobial, which kills most bacteria, fungi and yeasts, including MRSA, to ensure a sterile product at all times. The bib has a soft, rubber inner layer which is waterproof and repels all liquids, and a top nylon layer which is wipe clean and stain proof. It also has a unique, fold out pocket so it can be used with or without the pocket. Suitable for children aged 5 and over, teenagers and small adults. Neck diameter 110-125mm (4¼ to 5"). Shoulder width 290mm (11½"). Total length 500mm (9¾"). Machine washable at 40°C.

09 115 8161



DISHWASHER SAFE

This product is suitable for use in a dishwasher.

1 Easi-Grip Scissors

Easi-Grip Scissors are extremely lightweight with plastic handles and stainless steel blades. The continuous loop handle automatically reopens the scissors when pressure is released. As they require only a gentle squeeze to operate them, they can be used between fingers and thumb or fingers and the palm of the hand. Ideal for early scissor use, skill development or for those with weak hands. They are supplied with a blade guard and are available with round or pointed blades. They can be used either right or left-handed.

	Length	Style	Hand	Weight
AA6710	45mm	Round End	Right	30g
09 118 2617	45mm	Round End	Left	30g
AA6714	45mm	Pointed	Right	30g
AA6716	75mm	Pointed	Right	46g
09 118 2625	75mm	Pointed	Left	46g

Mini Easi-Grip Scissors

AA6711	24mm	Round End	Both	16g
---------------	------	-----------	------	-----

2 Self-Opening Scissors

Self-Opening Scissors look like conventional style scissors but have been fitted with a spring so that they automatically reopen after pressure is released. They are supplied with a blade guard and are available in either left handed (Green) or right handed (Blue) styles. Blades are round ended, stainless steel. Blade length 45mm. Weight 30g.

AA6740R Right Handed

AA6740L Left Handed

3 Dual-Control Training Scissors

A double set of handle loops allows the therapist and patient to simultaneously complete the cutting action. The patient uses the set of loops furthest from the blade whilst the therapist uses the loops closest to the blades. This allows the therapist to teach control, strength and guidance whilst the patient learns the action of opening and closing the blades. Available in either left handed (Green) or right handed (Blue) styles.

		Blade Length	Blade Style
AA6741R	Right Handed	45mm	Round End
AA6741L	Left Handed	45mm	Round End
AA6742R	Right Handed	75mm	Pointed
AA6742L	Left Handed	75mm	Pointed

4 Universal Art Tool Holder

These innovative art tools provide adaptive holding methods to paint with ease. The tools fit children aged six to 12. The Universal Art Tool Holder (cuff) fits right or left hand, and holds the art brush in palmar pocket using the plastic 'L' attachment. Made of soft nylon neoplus It has a Velcro brand hook and loop closure.

Measures: Length 65mm (2½"). Diameter 25mm (1"). Shaft 30mm (1¼").

954801 Universal Art Tool Holder

5 Mounted Table Top Scissors

This device has scissors mounted on a plastic base, with rubber non-slip feet. The scissors are operated by depressing the "T" shaped handle and the spring will automatically reopen the blades once the pressure is released. Suitable for use by those with only one functional hand.

09 116 3542 45mm Round Ended Blade

09 116 3559 75mm Pointed Blade

6 T-Bar Brush Holder

The T-Bar Brush Holder provides leverage and added stability for an art brush.

954803 T-Bar Holder

7 Scissor Assessment Kit

A kit designed specifically for Paediatric Occupational Therapists and other professionals working in the field of special education. The kit contains 15 different adapted scissors of 10 different styles together with guidance notes on their benefits and applications. Left handed versions of the scissors are included where available and all self-opening types are provided with blade guards for safety when not in use. The comprehensive kit allows the therapist to find the most appropriate scissors for their client. Supplied with a carry case to provide storage and easy transport.

09 116 3567

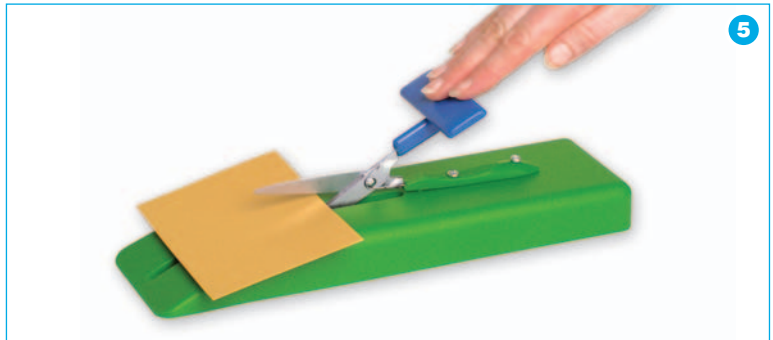
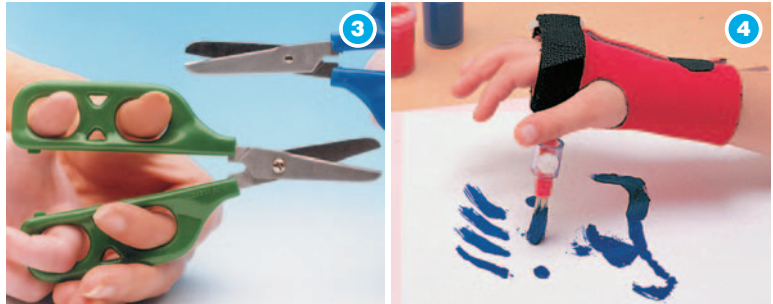
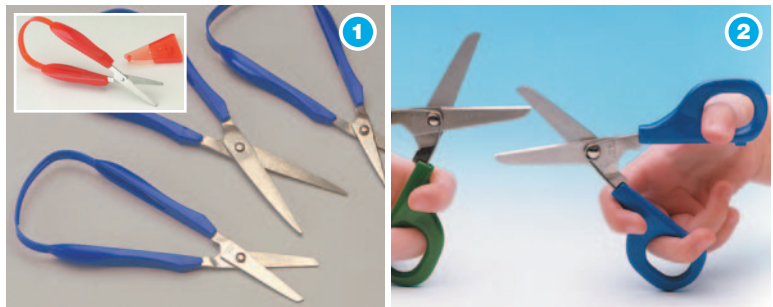



1 Etac Contour Rheumatic Pen

This ball point pen with lightweight plastic case is especially suitable for arthritics and rheumatics. The built-up contoured shape is easy to grip, and virtually no pressure is required when writing. It can be weighted with sand etc for those with a tremor. Length 150mm (6"). Diameter 18mm (3/4"). Weight 27g. Parker replacement refills are available at any good stationers.

AA7217

2 Steady Hand Magnetic Writing Instrument

A lightweight, ergonomically designed magnetic writing instrument. Includes a magnet located in the base, standard metal work surface (12 x 18"), and 3 buffer caps of varying thickness that accommodate all levels of tremors (mild, moderate, and severe). Suitable for children and adults.

920253

3 Ring Pen

Takes most of the tremor and muscle pain out of handling a pen. One finger goes through the ring creating a solid grip and the ergonomically designed barrel provides a natural resting place for the writing finger. The barrel fits snugly between two other fingers so there is no pressure and no pain.

Can also be used as a toe pen. The pen has blue ink and includes two refills.

AA7111

AA711101 Replacement Refills

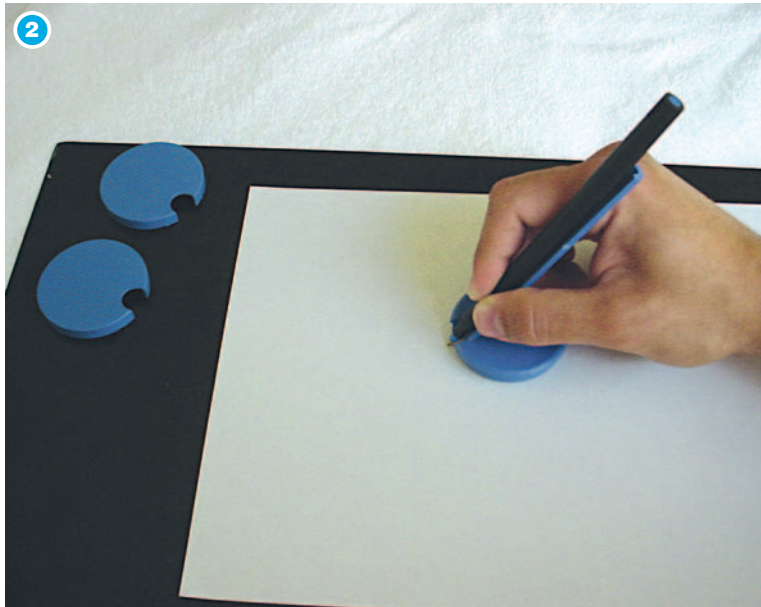

1 Pen and Pencil Holder

This soft PVC moulding slides on to normal sized pens and pencils to make them easier to grip and control writing. Internal diameter 8mm. Available in packs of 3. Weight 22g.

AA7200SY Mixed - Retail Packed

AA7200SW Mixed - Non Retail

2 Weighted Universal Holders

These helpful holders have plastic vinyl contoured handles for improved grasp and control. They securely hold most round or irregularly shaped items by means of three adjustable set screws. Diameter 22mm (7/8"). Length 89mm (3 1/2").

Holds items 7mm (9/16") in diameter. Comes with No. 2 pencil and Allen key. Weight 112g.

402101 Adult Size

402102 Paediatric Size

555734 Standard Handle

3 Grippit

The Grippit's simple design enables those with poor grip to control and hold a range of implements - pens, pencils, toothbrushes, knives, forks, etc. The larger ring is placed on the thumb or finger and the item to be gripped is slotted into the smaller ring. Suitable for both left or right handed use. The design ensures that it is impossible for the user to drop the implement. Supplied in packs of 3.

AA7204A Small

AA7204B Medium

AA7204C Large

4 The Pencil Grip

Encourages writing with full hand/arm action. Pear shaped design promotes correct gripping and prevents finger cramping and user discomfort. Fits any standard pencil or pen. For right or left handed users.

4026 Pack of 3

402601 Pack of 12



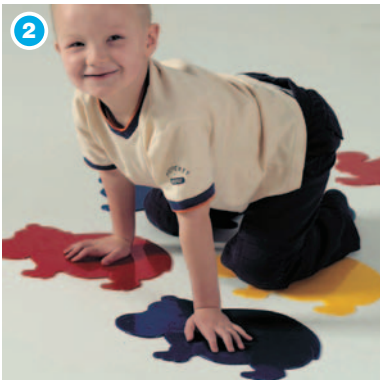

1 Tortoise Play Mat
 Shaped mats designed specifically for paediatrics bring fun to the Dycem range. The tortoise shaped mat is ideal for use as a place mat or on top of writing boards for a safe and effective non-slip surface. Available in three colours.
 Length 355mm (14"). Width 250mm (10"). Depth 2.5mm (1/10").
AA6871B Blue
AA6871F Red
AA6871I Yellow

2 Hippo Play Mat
 The hippo shaped mat is ideal for use as a place mat or on top of writing boards for a safe and effective non-slip surface. Available in three colours.
 Length 355mm (14"). Width 250mm (10"). Depth 3mm (1/10").
AA6872B Blue
AA6872F Red
AA6872I Yellow

3 Hippo Seat Mat
 The hippo seat mat is made from Dycem foam and has a non-slip surface. It is soft and flexible and stops slipping and sliding on chairs. It provides stability with fun.
 Length 355mm (14"). Width 250mm (10"). Depth 2.5mm (1/8").
AA6873

4 Dycem® Reels
i INFORMATION
 For a wider range of Dycem products, please see pages 1160 to 1162 in the Household section.

Dycem coloured reels are made from a non-woven fabric coated with non-slip properties. They can be used to cover large areas or cut to shape and are especially suitable for moulding or wrapping around an object. The clear and check reels are made from a polythene base and are of a stiffer construction. They are more suitable for flat surfaces or when extra firmness is required.

Dycem Reels										
Length x Width	Weight	White	Blue	Red	Green	Yellow	Check	Clear	Silver	
1m x 200mm (3'3" x 8")	220g	AA6854A	AA6854B	AA6854F	AA6854G	AA6854I	AA6842A	AA6858A	AA6854S	
1m x 400mm (3'3" x 16")	410g	AA6856A	AA6856B	AA6856F	AA6856G	AA6856I	AA6842B	AA6859A	AA6856S	
2m x 200mm (6'6" x 8")	344g	AA6830A	AA6830B	AA6830F	AA6830G	AA6830I	AA6842C	AA6858B	AA6830S	
2m x 400mm (6'6" x 16")	592g	AA6840A	AA6840B	AA6840F	AA6840G	AA6840I	AA6842G	AA6859B	AA6840S	
9m x 200mm (10yds x 8")	990g	AA6834A	AA6834B	AA6834F	AA6834G	AA6834I	AA6842D	AA6858C	AA6834S	
9m x 400mm (10yds x 16")	2.1kg	AA6844A	AA6844B	AA6844F	AA6844G	AA6844I	AA6842E	AA6859C	AA6844S	