

Household

RevoReach™	642 - 643
Homcraft Pick-Up Reacher	644
Homcraft Handi-Reacher™	645
Homcraft Easireach II	646
Reachers	647
Plastic Grab Rails	648 - 651
Homcraft Grab Rails	652 - 654
Homcraft Steel Rails	655
Steps & Stools	656
Tap Turners	657
Gripping & Turning Aids	658 - 659
Dycem® Non-Slip Solutions	660 - 664
Home Accessories	665
Clocks & Watches	666
Magnifiers & Lighting	667 - 668
Reading & Writing Aids	669
Scissors & Leisure	670

REVOREACH

Revolutionary Design

Sleek and modern, the RevoReach™ has been designed with the user in mind. The contemporary design is robust and uses ergonomic principles, making the product range as comfortable to use as possible.

Revolving Jaw

The revolving jaw head allows objects to be picked up from a variety of angles. It can be locked in position at 30° angles for increased flexibility.

Lightweight & Well Balanced

The correct balance of a reaching aid can be a significant factor when it comes to providing optimum control and a secure grip. For this reason the weight is distributed towards the handle making the reacher easier to control.

Key Features

- Ergonomic handle design reduces finger and wrist strain
- Attractive slip-resistant handle provides a more secure grip
- Robust construction for security and durability
- Slip-resistant ridged jaws provide additional grip when picking up objects
- Adjustable rotating jaw head operated by a pull and twist action offers flexibility - Adjustable in 30° increments
- Two models available to suit user requirements





1 RevoReach™ Xcel

This robust reacher benefits from an ergonomically designed handle with a trigger that requires minimal finger extension and allows the use of all fingers for a more powerful grip. The short trigger design is ideal for anyone with arthritic fingers or a weak grip.

	Length	Weight
091204825 Standard	660mm (26")	210g
091204833 Long	810mm (32")	230g



2 RevoReach™ GripLock

This unique reacher has additional features, making it as easy to use as possible. The GripLock benefits from an innovative locking mechanism that allows the jaws to be locked in place once an item is gripped, enabling the user to concentrate their efforts on moving the object, rather than maintaining their grip of the item. There are three main functions of the lock:

- **Standard Lock** - The standard locking feature allows the lock to be engaged using either the thumb or hand to turn the locking catch. This allows the user to grip an object then engage the lock once they have achieved a secure hold
- **Grip & Hold** - This innovative function allows the lock to be set so that as the trigger is squeezed, the jaws automatically lock. This is ideal for anyone who lacks the dexterity to use the lock catch when gripping an item, and is also very useful for gaining a tighter hold on an item that has already been gripped
- **Fine Tune Grip** - a useful feature that allows the jaws to be locked half way so they have a smaller range of movement. This is a useful function when picking up smaller objects as it allows a more precise grip and allows the reacher to retrieve items from tight spaces

	Length	Weight
091204791 Standard	660mm (26")	220g
091204809 Long	810mm (32")	240g



RETAIL PACKAGED
These products are supplied in retail packaging.

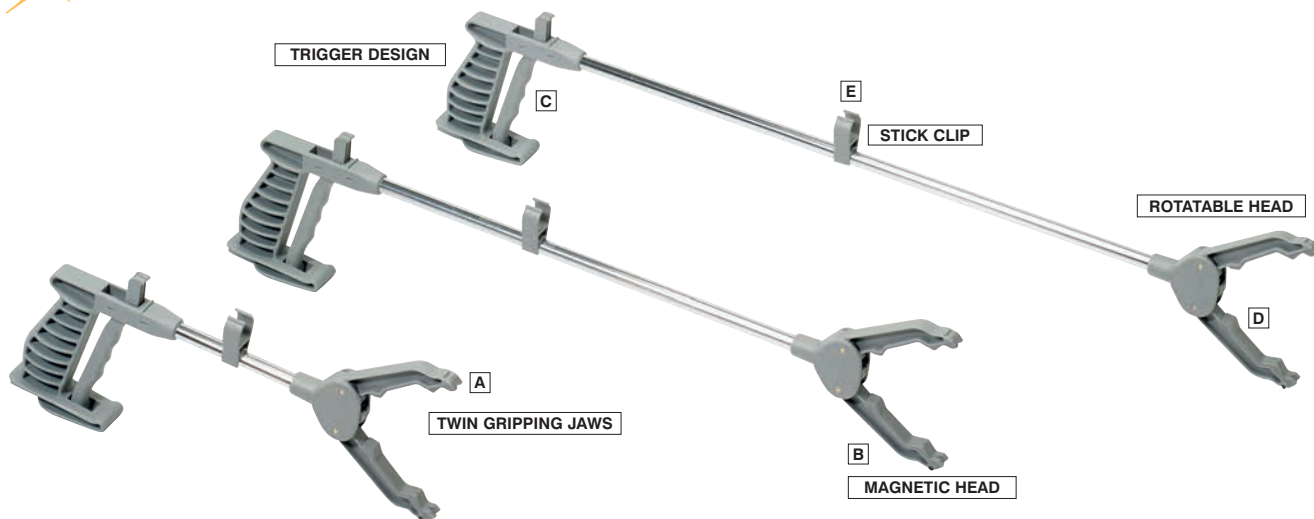

1 Homecraft Pick-Up Reacher

A unique lightweight, robust and wear resistant reacher. Ideal for retrieving or reaching a wide variety of items in the home, garden or out shopping. Available in four lengths, with or without optional extras.

Features

A Twin Gripping Jaws

The jaws have sculptured liners which give an excellent grip. The Pick-Up is operated by a wire not a cord eliminating fraying or stretching.

B Magnetic Head

There is a magnet attached to the jaw which allows easy retrieval of pins, paper clips and other small ferrous items.

C Trigger Design

The trigger is designed for comfort and is large and roomy to allow use of all fingers. The short trigger distance is ideal for stiff, arthritic fingers. The trigger projects through the top of the handle to allow it to be squeezed in the conventional manner, or pushed using the palm of the hand.

D Rotatable Head

The head can easily rotate to suit individual tasks.

E Stick Clip

The Pick-Up is supplied with a removable stick clip, allowing it to be clipped on to wheelchairs and walking frames etc.

Specifications	Length	Weight
Short	340mm (13 1/2")	170g
Standard	600mm (24")	215g
Long	750mm (30")	235g
Extra long	900mm (35 1/2")	250g

081306489	Short Pick Up Reacher
091114453	Standard Retail Packed
081306430	Standard Non Retail
081126333	Standard with Lock and Forearm Support
081306448	Standard Pick Up with Lock
091114503	Long Retail Packed
081306455	Long Non Retail
091114511	Long with Lock and Forearm Support
081306497	Extra Long Retail Packed



RETAIL PACKAGED
These products are supplied in retail packaging.

SPARES
Spares are available for this product, for details and full spares listing please contact Customer Services.



1 Homecraft Handi-Reacher™

An ultra lightweight, robust reacher that will assist those with restricted reach and/or mobility problems. Features a single moving jaw operated with a trigger action from the handle. The head is complete with a magnet for picking up small metal objects e.g. pins and a hook to aid dressing. The jaw may be rotated 360° to avoid the need to rotate the wrist which may be painful to certain users. The trigger operated by four fingers instead of the usual two is easy to grip and operate.

	Length	Weight
081306414	Standard Retail 610mm (24")	180g
091114339	Standard 610mm (24")	180g
081306422	Long Retail 760mm (30")	200g
091114388	Long 760mm (30")	200g
091114420	X-Long Retail 900mm (36")	220g
081126317	X-Long 900mm (36")	220g



RETAIL PACKAGED
These products are available in retail packaging.



1 Homecraft Easireach II

Made from lightweight aluminium, this reacher is designed for people with limited reach and/or mobility. The jaw opening is highly visible and features a slip resistant surface for a secure hold on the object. Available in standard or folding versions. Constructed with a cord running through the tube, which operates the plastic jaw. This cord style allows the reacher to be folded in the centre for ease of storage and transportation. All models include a magnet tip, a hook for dressing, a rubber lined jaw and a device that allows the reacher to be clipped to a stick or walker.

	Length	Weight
091114248	Standard 380mm (15")	147g
091114255	Standard 530mm (21")	172g
091114263	Standard 660mm (26")	198g
091114271	Standard 810mm (32")	227g
091114289	Folding 660mm (26")	198g
091114297	Folding 810mm (32")	227g



RETAIL PACKAGED

These products are supplied in retail packaging.



PRICES

For up-to-date prices please see our Website, alternatively contact your Sales Representative or Customer Services.

1 Sammons Preston Lightweight Reachers

A high quality durable aluminium reacher that is extremely lightweight and ergonomically designed for comfort. Designed for picking up objects, the reacher's serrated high visibility yellow jaw and flexible foam rubber tip conform to the contours of any object, working together to ensure a firm, secure grip. Hands remain comfortable on the ergonomically designed trigger action handle. Available as a standard model in 660mm (26") and 810mm (32") lengths or a folding model, 660mm (26") long for easier transportation. The jaw opens to 76mm (3").

	Length	Weight
081022524	Long 810mm (32")	225g
081022565	Folding 660mm (26")	196g
081022607	Standard 660mm (26")	168g

2 Suction Top Reacher

Aluminium reacher with circular rubber tips that provides a powerful secure grip. The large trigger can be operated by using the palm of the hand, making it easier for people with limited finger strength. The suckers operate by being pulled together by two metal strips rather than by a cord that can stretch or break. This gives a stronger more secure and durable grip. Two lengths available.

091114610	508mm (20")
091114628	762mm (30")



SammonsPreston



HIGH VISIBLE 76mm YELLOW JAW



RUBBER TIP CONFORMS TO ANY OBJECT

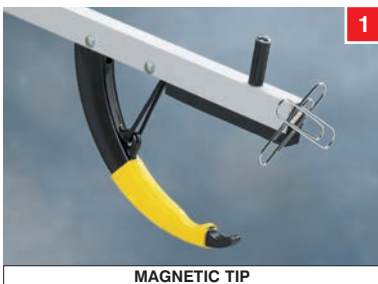

MAGNETIC TIP



ERGONOMIC HANDLE





COVERING DISC

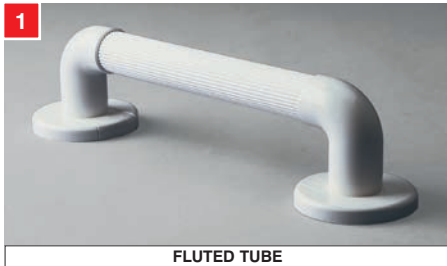

FLUTED TUBE



A



B



C



D



1 Homecraft Moulded Fluted Grab Rails

This cost effective range of plastic grab rails is made from white PVC tubes with moulded end fittings. They have circular fixing plates which have a covering disc supplied that clips into place, hiding the screw heads. The tubes are fluted along their length to provide better grip for wet hands. Diameter of tubes 38mm (1 1/2"). Distance from wall 50mm (2 1/3"). Disc diameter 91mm (3 3/5"). No electrical earthing required. The covering disc is available as a spare, making this product suitable for refurbishment.

	Length	Weight
081306174	305mm (12")	295g
091101641	381mm (15")	370g
081306190	410mm (16")	395g
081306208	457mm (18")	440g
081306216	610mm (24")	595g
081306224	914mm (36")	885g



2 Homecraft Moulded Fluted Grab Rail System

This high quality grab rail system has been designed around the popular moulded fluted grab rails. The bars can easily be cut to any length and then slotted into a choice of fittings. Most runs can be accommodated using the T-Pieces and 90° elbows. The rail can be completed with end caps in T-Pieces or standard end brackets as used with the standard fluted rails. All of these can be purchased separately. As the fluted bars fit into ribbed sections, the bars will not twist in a users grip. We recommend that a standard solvent adhesive be used at all of the joints between the various parts. No electrical earthing is required.

- 091101765** A T-Piece - Pack of 2
- 091101799** B 90° Elbow
- 091101831** C 800mm Bar
- 091101773** D End Bracket

RETAIL PACKAGED
These products are supplied in retail packaging.

SPARES
Spares are available for this product, for details and full spares listing please contact Customer Services.

INFORMATION
Rail length measurements are from the centre of the fixing plate. The maximum user weight/load for these products is dependent upon the choice of fixings used and the mounting surface. For this reason, all rails should be installed by a person who has suitable qualifications and/or experience in installing this type of product, ensuring the fixtures are appropriate for the specific installation.

1 Days EasyBar Suction Grab Rail

The EasyBar suction grab rail offers a sturdy and safe support to the user without having to screw the product to the wall. It benefits from safety lock indicators that display green when secure and red when the rail is not secured. It is designed for use only on smooth and non-porous surfaces such as tiles, glass, porcelain or fibreglass. Ideal for assisting the user when standing and suitable for temporary or permanent use. No fixings required, making it very convenient when away or travelling.

091325786 **A** 350mm (13³/₄")

091325802 **B** 500mm (19¹/₂")



days

2 Homecraft GripSure™ Grab Rail

GripSure grab rails have soft, ribbed mouldings to provide additional grip in wet areas. They are warm to the touch and the subtle, stylish design makes the rails suitable for use in a variety of areas around the home. The ergonomic elliptical rail is easy to grip and can be mounted horizontally, vertically or diagonally. The oval shaped fixing plates have an attractive covering that clips easily into place. Diameter of rails 37mm. Distance from wall 37mm. Rail length measurements are from the centre of the fixing plate. No electrical earthing required.

091187822 300mm (12")

091187830 400mm (16")

091188077 450mm (18")

091188093 600mm (24")



homecraft



homecraft



RETAIL PACKAGED

These products are supplied in retail packaging.



INFORMATION

Rail length measurements are from the centre of the fixing plate. The maximum user weight/load for these products is dependent upon the choice of fixings used and the mounting surface. For this reason, all rails should be installed by a person who has suitable qualifications and/or experience in installing this type of product, ensuring the fixtures are appropriate for the specific installation.



1 Prima Grab Rails

An innovation in safety grab rail design. The Prima grab rails feature special soft grip mouldings around the bar to reduce the risk of slipping, even with wet soapy hands. The bars are strong, one-piece moulded plastic with the super reinforced strength of an internal non-rust aluminium tube. The ergonomic grip is comfortable and never cold to touch. The straight bars can be mounted horizontally, vertically or diagonally. The two specially designed angled rails are ideal for the toilet, helping the users with weak hand strength to rise from the seat. Available in a range of six different lengths and angles to suit most locations.

Mint	White	Length
091101898	091158732	300mm (12")
091101906	091158740	400mm (16")
091101914	091158757	450mm (18")
091101922	091158765	600mm (24")
091101930	091158773	Angled 325mm (13")
091101948	091158781	Angled 400mm (16")

Maximum user weight



MAXIMUM LOAD
The maximum user weight/load given for these products is dependent upon the correct choice of fixings for the mounting surface. For this reason, all rails should be installed by a person who has suitable qualifications and/or experience in installing this type of product, ensuring the fixtures are appropriate for the specific installation.

1 Natural Grip Plastic Grab Rails

Ergonomically designed grab rails that provide the best possible shape to fit the users hand. Made from polypropylene with a stainless steel moulded insert throughout the length of the rail for additional strength. Suitable for inside or outside use. No electrical earthing required.

	Length	Diameter(Narrowest/Widest)
091100882	300mm	25mm/32mm
091100908	450mm	25mm/32mm
091100924	600mm	25mm/32mm

2 Prima Outdoor Grab Rail

The Prima Outdoor Grab Rail has been designed to assist in entering and exiting the home. The subtle colour allows the bar to blend into its surroundings and be more discreet when positioned on brickwork or a darker background. The bar gives superior grip and strength due to the slip resisting rings and the aluminium inner core.

	Length
091158658	450mm (18")

Maximum user weight



RETAIL PACKAGED
These products are supplied in retail packaging.



Homecraft Rails are suitable for both indoor and outdoor use.

1 Homecraft Ringwood Rails

This range is made in larger diameter steel tubing for greater comfort and easier grip. Available in either epoxy or chrome finish. Made from 32mm (1 1/4") diameter steel tube.

White Epoxy Coated

	Length	Weight
091100874	305mm (12")	440g
091101138	457mm (18")	660g
091101195	610mm (24")	880g
091101211	914mm (36")	1.3kg

Chrome

091101120	305mm (12")	410g
091101187	457mm (18")	630g
091101203	610mm (24")	850g
091101229	914mm (36")	1kg

2 Homecraft Steel Grab Rails

These steel grab are made of 25mm (1") steel tubing and powder coated for durability.

	Length	Weight
091393230	445mm (17 1/2")	455g
091393248	610mm (24")	620g
091438894	685mm (27 1/2")	705g
091100858	890mm (36")	865g

3 Homecraft Angled Steel Grab Rails

This is an offset, angled version of the standard steel grab rail. Used where hand access may be difficult, for example, near a door jamb. Available in white, epoxy-coated steel.

	Length	Weight
091100775	445mm (17 1/2")	455g
091100841	715mm (28")	705g

4 Homecraft Chrome Rail

These chrome plated steel rails are both durable and practical. They have a patterned, indented grip to help prevent hands slipping on them. The tubing is a comfortable 25mm (1") in diameter and they stand off from the wall by 38mm (1 1/2"). Available in five sizes.

091101427	305mm (12")
081570464	406mm (16")
081570472	450mm (18")
081570480	610mm (24")
091101484	812mm (32")

INFORMATION
 Rail length measurements are from the centre of the fixing plate. The maximum user weight/load for these products is dependent upon the choice of fixings used and the mounting surface. For this reason, all rails should be installed by a person who has suitable qualifications and/or experience in installing this type of product, ensuring the fixtures are appropriate for the specific installation.



1 Homecraft Polished Stainless Steel Grab Rails

The polished rails are available in either an elegantly simple straight rail design or a sleek curved rail design to add a touch of style to any bathroom. Both designs are available in three sizes. Diameter of rails 32mm (1 1/4"). Distance from wall 50mm (2").

Straight	Length
091329101	305mm (12")
091329119	450mm (18")
091329127	610mm (24")
Curved	
091329143	305mm (12")
091329150	450mm (18")
091329168	610mm (24")



1

Household



1



RETAIL PACKAGED

These products are supplied in retail packaging.



INFORMATION

Rail length measurements are from the centre of the fixing plate. The maximum user weight/load for these products is dependent upon the choice of fixings used and the mounting surface. For this reason, all rails should be installed by a person who has suitable qualifications and/or experience in installing this type of product, ensuring the fixtures are appropriate for the specific installation.

1



1 Homecraft Chrome Plated Steel Grab Rails

These stylish chrome plated steel grab rails are hard wearing and ideal for bathrooms or around the home. Made from 25cm (1") diameter steel tubing.

Length

091357276 305mm (12")

091357284 460mm (18")

091357292 610mm (24")

091357300 910mm (36")

2 Homecraft Powder Coated Steel Grab Rails

These steel grab rails are powder coated for durability and strength making them ideal for bathrooms or anywhere around the home. Made from 25cm (1") diameter steel tubing. Pre-drilled fixing holes in flanges.

Length

091325349 305mm (12")

091325364 460mm (18")

091325380 610mm (24")

091357342 910mm (36")

2



INFORMATION

Rail length measurements are from the centre of the fixing plate. The maximum user weight/load for these products is dependent upon the choice of fixings used and the mounting surface. For this reason, all rails should be installed by a person who has suitable qualifications and/or experience in installing this type of product, ensuring the fixtures are appropriate for the specific installation.



1 Homecraft Steel Newel Rail

This white, epoxy coated steel rail turns 90° around the newel post, avoiding the need to let go. There is a left and right handed version, as viewed looking up the stairs (091101369 pictured). Length 673mm (26 1/2"). Diameter 25mm (1") coated steel tube. Weight 720g.

- 091101351 Left
- 091101369 Right

2 Homecraft Ringwood Wall to Floor Grab Rail

Based on the popular Ringwood range of grab rails. This Wall to Floor Grab Rail is made in larger diameter steel tubing for greater comfort and easier grip. The rail has a diameter of 32mm (1 1/4") and a white epoxy coating that makes it suitable for indoor or outdoor use. The rail fixes to the floor and wall measuring 760mm (30") from the floor and 780mm (30 3/4") from the wall. For easy storage and transportation the rail comes in two pieces and is self assembly (by a simple but extremely strong bullet catch mechanism).

081330901

3 Homecraft Handy Rail

This unique and practical rail has been designed in conjunction with Physiotherapists, Occupational Therapists and Manual Handling Advisors. The rail is designed to provide support when navigating steps up to the door of a house and is suitable for use on step inclines from one to four steps.

- Designed to replace permanent rails with concreted in posts, reducing installation time significantly
- The rail can be installed either way round to suit different step inclines
- Can also be used to provide support at the side of a toilet or wash basin
- Suitable for indoor or outdoor use
- Manufactured from durable powder coated steel

Specifications

Height: 710mm

Distance from wall: 510mm

Length of rail: 540 or 400mm depending on fitting position (long rail section at top or bottom)

Weight: 4.6kg

091524149





homecraft

1 Homecraft Step Stool

A simple, sturdy stool consisting of a chrome plated steel frame with a non-slip rubber mat. The rubber ferrules provide a good grip on slippery surfaces. Top area 279×356mm (11×14"). Base area 305×406mm (12×16"). Height 225mm (9").

091102698 With Rail

091102680 Without Rail

Maximum user weight



2 Derby Half Step

The Derby Half-Step halves the door step rise for those with limited mobility. The large platform allows the user to become steady before attempting the actual step. The plastic construction ensures that the step is tough yet will not rust. It comes complete with a slip resistant rubber mat. The four feet are adjustable to ensure that the step can be levelled for use. Step length 400mm (15 3/4"). Width 740mm (29"). Height 110mm (4 1/4").

081533777

Maximum user weight



3 Bigfoot Half Step

The Bigfoot Half Step meets the needs of anyone who finds the height difference between a door and the ground outside too much to achieve in one go, such as at patio doors. The step halves the height between the door and the ground, allowing the user to be steady on the large surface before attempting the next step.

It is height adjustable from 100-120 mm (4-5") to offer the perfect step height, and it offers a high weight limit of up to 50 stones (318 kg).

Optional handles can be fitted on the left, right or both sides, to give additional support when stepping down. It is also supplied with a security fixing kit for the best possible stability and to prevent it being taken away.

The plastic half steps is built for the outdoors: it's long-lasting even in cold or heat and will not rust. The step has four over-moulded feet which grip firmly against the ground and offer adjustability, so that the step can be made level on uneven ground.

091558303 Bigfoot Half Step

Maximum user weight



£ PRICES
For up-to-date prices please see our Website, alternatively contact your Sales Representative or Customer Services.

1 Homecraft Tapturn Turners

These strong moulded turners simply hook over the top of a X type tap, to make it easy to turn. They are supplied as a Red and Blue pair for hot and cold taps. Length 140mm (5½"). Weight 65g.

091102102 Retail Packed - Pair

091102094 Non Retail - Pair



2 Derby Tap Turners

Attractive, easy to use tap turners that can be used on crosshead and crystal taps. The soft textured handles provide a comfortable and secure grip whilst in use. There is no installation required due to the screw handle that tightens the grip on the tap. Colour coded so that those with limited vision can identify the required tap. Length 180mm (7⅓"). Width 70mm (2¾"). Height 45mm (1¾").

091102169



3 Homecraft Crystal Tap Turner

This ingenious device clamps around the top of cylindrical tap tops, and provides the leverage to turn them easily. The barrel of the handle is spring loaded to allow the jaws to clamp down on the tap, which is gripped by soft non-slip rubber linings in the jaws. The jaws can also be locked in position. The handle is comfortable and easy to grip. For use with taps up to 60mm (2½") in diameter. Closed length 190mm (7½"). Weight 112g.

091102151 Retail Packed

091102144 Non Retail



1



2



3



RETAIL PACKAGED
These products are supplied in retail packaging.



1 Homecraft Contour Turner

This device is used to give good leverage for turning small difficult household items e.g. gas or radiator taps. The head has a bed of sprung stainless steel rods, which when pressed around an object, retract, conform around its shape, and provide a purchase around it when the handle is turned. The handle is a black plastic T-piece, which is easy to grip. It is small enough to be carried around in a pocket or hand bag. Head size 95mm (3³/₄" wide. 50mm (2" deep. Weight 130g.

081499623



2 Homecraft Key Turners

The Homecraft key turners have generous curved built up handles for holding keys. They provide an easy grip and good leverage for turning any Yale or mortice type door key. The two and three key turners feature a locking lever that allows keys to be folded into the handle when not in use.

A One Key Turner

081306232 Retail Packed

B Two Key Turner

091102250 Retail Packed

081306240 Non Retail

C Three Key Turner

091102235

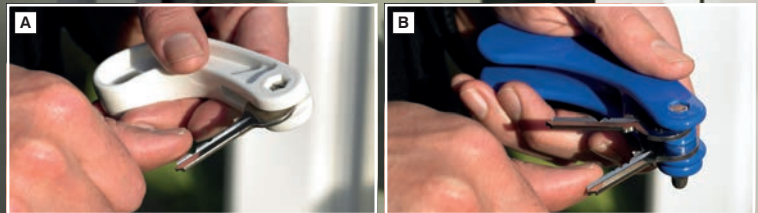

RETAIL PACKAGED
These products are supplied in retail packaging.

1 Think Plastozote Foam Tubing

Closed cell foam tubing available in various sizes to provide a built up handle for easier gripping e.g. cutlery, pens etc. It is non-absorbent, non-sticky, washable and dishwasher safe. Supplied in one metre (39") lengths, it may be cut to size. Exact lengths may vary plus or minus 50mm. External Diameter 31mm (1 1/4")

	Colour	Int. dia.	Weight
091101963	White	6mm	55g
091101971	Grey	6mm	55g
091101989	White	9mm	60g
091101997	Grey	9mm	60g
091102003	White	12mm	65g
091102011	Grey	12mm	65g
External Diameter 19mm (3/4")			
091101955	White	6mm	30g



2 Closed Cell Foam Tubing

Use for building up tool and utensil handles to give greater control to people who lack coordination, strength or gripping ability. Tubing has a slip resistant outer layer and is dishwasher safe. The tubing is 300mm (12") long and can be cut to the required length. Comes in packs of six. An assortment (two of each) is available for adults and children. The paediatric assortment comes in bright colours (Yellow, Orange and Blue). This is also suitable for the visually impaired.

081169713	Tan	Inner diameter 6mm (1/4") Outer diameter 22mm (7/8")
081169721	Red	Inner diameter 10mm (3/8") Outer diameter 28mm (1 1/8")
081169739	Blue	Inner diameter 16mm (5/8") Outer diameter 28mm (1 1/8")
091102037	Adult Assortment (2 of each)	
091102029	Paediatric Assortment (2 of each)	



2



DISHWASHER SAFE
This product is suitable for use in a dishwasher.



Different colours improve hand-eye coordination



Use under pillows and cushions to stop sliding



Placemats for independent eating and dining



Cut to size to create a secure surface anywhere



For easy opening of bottles



Dycem non-slip roll has many uses



Self adhesive non-slip strips for an enhanced built-up grip



Dycem products make a difference every day

Dycem® non-slip[©]

Making Life Easier

Dycem Non-Slip has been specially designed to overcome many of the stabilisation and gripping problems encountered by people in hospitals, care homes, clinics, at home and on-the-go.

Dycem products have been widely used by therapists for many years, serving people with special needs and/or visual impairments.

Dycem is also a great aid for those who have had a stroke or who simply need a little extra help.

The products are not-sticky but grip firmly on both sides to provide support, stability and confidence during every day activities and exercise.

Dycem Non-Slip:

- Multipurpose – grips, holds and opens
- Long-lasting – easy to clean and reuse
- Non-toxic and latex-free
- Dycem products contain an antimicrobial which has been proven to inhibit the growth of Campylobacter, E.coli, Listeria, MRSA and Salmonella
- Has been proven to grip objects at an angle of up to 45°

1

Prevent unwanted movement or spillages in a totally flexible way by using a Dycem Non-Slip Reel. Simply cut the section or shape you want and grip anything with ease. The reels provide unbeatable grip for any item. They fit discreetly under items in the clinic or home, or in your pocket when out on the go.



1 Dycem® Reels									
Length×Width	Weight	○ White	● Blue	● Red	● Green	● Yellow	● Silver	● Lime	● Pink
1m×200mm (3'3"×8")	220g	091103530	091103548	091103555		091103571	091103589	091565316	
1m×400mm (3'3"×16")	410g	091103597	091103605	091103613	091103621	091103639	091103647	091565357	091565340
2m×200mm (6'6"×8")	344g	091103233	091103241	091103258	091103266	091103274	091103282	091565258	091565241
2m×400mm (6'6"×16")	592g	091103357	091103365	091103373	091103381	091103399	091103407	091565290	091565282
9m×200mm (10yds×8")	990g	091103290	091103308	091103316	091103324	091103332		091565274	091565266
9m×400mm (10yds×16")	2.1kg	091103472	091103480	091103498	091103506	091103514		091565332	091565324

2 | Dycem® Non-Slip Bulk Reel Dispenser

This dispenser can sit on a table. The non-slip material has a protective film on both sides, which will keep the material clean until ready to dispense. The protective film also makes cutting easier – pull out the desired length, cut and peel the film from both sides when ready to use. A smaller bulk roll is also available supplied in a card dispenser only.

- 091200021** Bulk Reel only 40cm×15m Blue
- 091200005** Bulk Reel supplied with Cardboard Dispenser 20cm×15m



CARDBOARD DISPENSER WITH 20cm BULK REEL

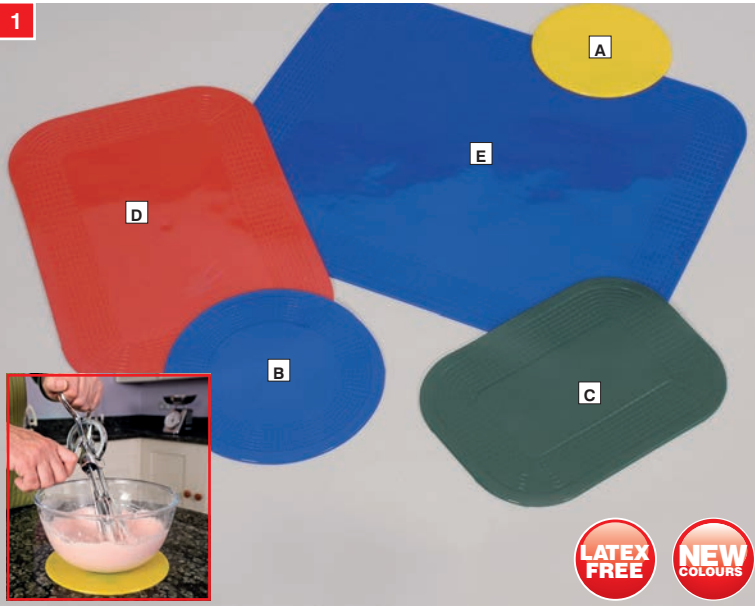

Anchor your items onto any surface with Dycem Non-Slip's long-lasting non slip mats.

Dycem non-slip mats provide unbeatable grip for any item and have been proven to grip up to a 45° angle. Keep your things secure by using them on a range of surfaces.

These easy to use non-slip mats are antimicrobial, making them very hygienic. They are also made from non-toxic materials and do not contain any latex. These anti slip mats have so many uses that you will struggle to find a place that you can't use them. They are available in a range of sizes and colours.



1 Dycem® Anchorpads

Size	Weight	● Blue	● Red	● Green	● Yellow	● Silver	● Lime	● Pink
A Round 140mm (5½")	74g	091102938	091102946	091102953	091102961	091102979	091565159	091565142
B Round 190mm (7½")	140g	091102987	091102995	091103001	091103019	091103027	091565175	091565167
C Rectangular 250×180mm (10×7½")	134g	091103035	091103043	091103050	091103068	091103076		
D Rectangular 350×250mm (14×10")	248g	091103084	091103092	091103100	091103118			
E Rectangular 380×450mm (15×18")	434g	091103126	091103134	091103142	091103159			



2 Dycem® Non-slip Floor Mat

Manufactured from Dycem's unique non-slip material, these floor mats create a safe and effective surface for those with limited dexterity or reduced mobility. They measure 450×600mm (17¾×23¾") and are available in Blue or Grey.

- 091102912 ● Blue
- 091102920 ● Grey

3 Dycem® Nose Over Toes Mat

This innovative floor mat is designed to provide better traction underfoot and to prompt the user to position their feet correctly and adopt an appropriate position when transferring in or out of a chair.

091535541



RETAIL PACKAGED
These products are supplied in retail packaging.

1 Dycem® Bottle Opener

The Dycem Non-Slip Bottle Opener allows you to effortlessly unscrew tough bottle tops. It is also helpful for opening medicine bottles and turning smaller door knobs. Particularly suitable for those with a weak grip and arthritis sufferers.

091095991 Yellow



1

2 Dycem® Jar Opener

Dycem Non-Slip Jar Openers allow you to open any jar with ease. They provide a tight grip for lids of all sizes. They're perfect for those with arthritis, weakened grip, decreased hand sensation or upper extremity weakness.

091095983 Blue
091202613 Silver



2

PICTURED WITH AA6810S ANCHORPAD

3 Dycem® Display Unit Counter Top Mats

A counter top display pack containing 25 Dycem round Mats (14cm diameter), ideally suited to retail environments. Dycem mats can be used for a variety of purposes where grip and stability are important. The Dycem Mats can grip up to angles of 45 degrees and they are ideal for eating and dining.

091182286 Blue

4 Dycem® Non-slip Netting

Stop unwanted movement with Dycem non-slip netting. Easy to use and made from soft mesh material, the extra padding makes Dycem Non-Slip Netting perfect for seating and positioning. Simply cut the non-slip netting to desired size and place on cushions and seats. The wide mesh allows air to circulate, preventing any clamminess whilst maintaining comfort. Non-slip netting is also great for placing under rugs to stop them from slipping. Size 600mm x 2m (24 x 78"). Weight 432g.

091103829

RETAIL PACKAGED
These products are supplied in retail packaging.



4



3



1



1 Dycem® Non-Slip coaster

A set of highly durable silver coasters designed to keep mugs and glasses in place. They fit beneath a standard sized mug or tumbler, providing a non-slip base on any dry surface.

Coasters can also be used beneath fragile ornaments or vases for a secure surface. Supplied as a set of four. (Each coaster measures 9×9cm)

091428754

2 Dycem® Non-Slip Self-Adhesive Strips

Dycem Self-Adhesive Strips are designed to provide a comfortable built-up grip for a variety of items including cutlery, pens, walking frame handles, remote controls and hairbrushes. The strips are manufactured from Dycem reel material with an adhesive on one side. They can easily be cut to the required length with scissors. Supplied as a pack of three.

091103837 Blue

3 Dycem® Super-Grip Tapes

Dycem super grip comfort tapes feature unique grip properties and a thick cushioned surface. The grips can be cut to size and used on a variety of items. The tape is great for wrapping around crutch handles and parallel bars. The tape can also be wrapped around utensils and mobility equipment handles for a comfortable built up grip.

7500259 Black

7500260 Blue

7500258 Red



2



2



2



3



1 Home Safety Alert

A wireless calling alarm system with one main receiver unit and two pendant calling transmitters. Call Button and Panic Button on each pendant. The main unit receives and recognises who is calling and the urgency using different sound and coloured light signals. A quick reset button on the main unit can cancel the call or alarm. Each transmitter uses 1 x 23A 12V battery (included) and the receiver unit is powered by a 6V adaptor (not included) or 4 x AA batteries (not included).

091105105



1

2 Homecraft Plug Pull

This self adhesive, plastic moulded T-piece fixes to the back of a standard three pin plug, and provides leverage for removing the plug from the socket. Supplied in a pack of 3. Also useful for drawers and doors where extra leverage is required. Weight 40g.

091102441 Pack of 3



2

3 Clearsound™ 100 Amplified Telephone

This volume and tone controlled amplified telephone is designed for people who find it hard to use a conventional telephone. It features receiving tone (+/-10dB), receiving volume control (up to 30dB gain) and speech volume gain (+/- 4dB). The telephone also has adjustable ringer volume and tone, a bright visual ringer indicator, 3 emergency memories and 9 direct memories. Hearing Aid compatible.

091203892

4 Dallas 10 Big Button Phone

This stylish telephone has an extra large keypad with easy-to-see big buttons making it very easy to use. It features receiver volume control up to 18dB, an adjustable ringer volume and super bright LED visual ringer indicator. It is Hearing Aid compatible and has 10 memory speed dials.

091224740



3



4

RETAIL PACKAGED
These products are supplied in retail packaging.

1



Designed in association with

RNIB supporting blind and partially sighted people

40 pence (excluding vat) per product sold is paid to REL which covenants all its taxable profits to RNIB a registered charity number 226227

1 Talking Atomic Watch

This attractive watch speaks the time and date in a clear voice with radio controlled accuracy. It automatically adjusts between summer and winter time and has an automatic setting function by seeking the time signal in countries where available including UK, Germany, USA and Japan. It can also be manually set for countries with no signal. It also includes an option of an alarm and hourly time announcement. The speech was recorded by the RNIB. Silver tone case with stainless steel bezel and either a leather strap or stainless steel bracelet. Battery included.

091201714 Mens Leather Strap

091534627 Ladies Leather Strap



2 Talking Alarm Clock

This alarm clock has a talking function and clear analogue face to assist the visually impaired. It has a dual time display and the voice announcement of the time activated by pressing the large button on the top of the clock. Includes options for voice announcement of temperature, alarm, hourly time announcement. Requires 2 x AA batteries (not included).

091146950



3 Wake 'n' Shake Vibrating Alarm Clock

This stylish and modern alarm clock is ideal for anyone who is hard of hearing. It features a large LCD display, and adjustable volume alarm (up to 95dB), a vibrating pad that can be placed under the pillow and a strobe light to wake the user. It has four alarm options: Shaker, Flash and Aarm, Flash and Shaker, Alarm and Shaker. It is easy to use and can also be used as a telephone ring alerter.

091225630



2



3



RETAIL PACKAGED

These products are supplied in retail packaging.

1 Hands Free Magnifier with Light

Can be used as a hand held or a hands free magnifier when used with the neck cord supplied. Ideal for reading, sewing or other hobbies. The lens face has a diameter of 105mm (4¹/₄") and a large magnification area of $\times 2$. A small central magnification area of $\times 4$ makes it suitable for close work. With a built in light, this magnifier can also be used in the dark. The cord can be stored away neatly within the handle. Length 250mm (10"). Width 120mm (4⁴/₅"). Depth 20mm (4⁴/₅"). Weight 200g. Requires 2 x AAA batteries (not included).

091104777**2 Round LED Magnifiers**

These hand-held LED magnifiers have scratch-resistant aspheric lenses offering 4 \times or 7 \times magnification. The LED light helps to highlight everyday text, maps and photos and provides bright, even illumination for close inspection tasks and hobbies. Ideal for use in areas of poor illumination or limited natural light. Comfortable to hold with a sensibly-positioned easy on/off switch on handle. Requires 3 AAA batteries (not included).

091329549 4 \times Magnification 75mm Lens**091329556** 7 \times Magnification 40mm Lens**3 Folding LED Rectangular Magnifier**

This stylish rectangular magnifier has an extra-bright, long-lasting LED illumination. It improves the contrast of lettering against the page thereby making reading more comfortable. Handle folds flat into body for compact storage. Lens size: 50 \times 75mm (2 \times 3"), 3 \times magnification. Supplied in gift box with protective pouch and button cell batteries giving up to 100,000 hours of bulb life.

091187004

£ PRICES
For up-to-date prices please see our Website, alternatively contact your Sales Representative or Customer Services.



1 Desk Top Magnifier

This unique hands-free magnifying stand has a fresnel-type swivel lens, which revolves 360°. Generous 160×110mm (6¼×4¼") lens (2×) makes light work of everyday or occasional inspection and magnification tasks. Lightweight plastic construction.

091170133

2 Full Page Magnifier

This full page flexible magnifier has a 'soft-touch' frame for positioning and comfort. Ideal for magnifying text, small print, maps and documents. Viewing area 250×180mm (9¾×7") with approximately 2× magnification.

091170091

3 High Vision Reading Light

These specially designed lamps use near daylight bulbs allowing you to read and concentrate for longer, helping to relieve eyestrain and headaches. They are ideal for hobbies or close work and are helpful for the elderly or anyone with limited vision. The flexible arm adjusts the angle and makes sure that the light always shines at the right height and from the right direction. Supplied with 27w near daylight low flicker bulb that is energy efficient and lasts up to 8000 hours.

091203710 **A** Floor Lamp

091203728 **B** Table Lamp

091203736 Spare Bulb



1 Homecraft Folding Book and Magazine Stand

This stand holds books or magazines open and upright for reading without using the hands, and can also be placed over the knees. Supplied with a book clip which is used to hold pages open, follow text or as a bookmark. It folds flat for storage. Size folded 305×229mm (12×9"). Weight 670g.

081306380

2 Booklift™ Copyholder

This easel-style book holder has nine height adjustments, which enables an individual to read from any size book at various viewing angles. Two adjustable clips hold reading materials open and in place. It folds flat for storage and portability. Measures 300×240×45mm (11¾×9¾×1¾") with a 38mm (1½") lip when open.

081021906

3 Book Holder Stand

The Book Holder Stand enables individuals with limited upper extremity function to read hands-free and without neck strain while sitting, standing or lying supine. The page holder's spring action and soft rubber ends make turning pages easy, even with one hand. The stand is height adjustable from 790mm (31") to 1300mm (51") and tilts and rotates around the horizontal axis.

081021997

4 Homecraft Pen and Pencil Holder

This soft PVC moulding slides on to normal sized pens and pencils to make them easier to grip and control writing.

Internal diameter 8mm. Available in packs of three. Weight 22g.

091104629 Mixed - Retail Packed

091104603 Mixed - Non Retail



5 The Pencil Grip

Encourages writing with full hand/arm action. Pear-shaped design promotes correct gripping and prevents finger cramping and user discomfort. Fits any standard pencil or pen. For right or left-handed users.

081021450 Pack of 3

081021468 Pack of 12



RETAIL PACKAGED
These products are supplied in retail packaging.



1 Easi-Grip Chiropodist Scissors

The long loop handles allow the whole hand to be used for controlling the scissors, which is ideal for those with a weak grip. The extended shank helps users who have difficulty bending and the angled blades give a good cutting position, with the top blade being slightly serrated to stop it slipping. The blades are made of stainless steel. Overall length 200mm. Blade length 30mm. Weight 55g.

091102870 Retail Packed



2 Easi-Grip Scissors

Easi-Grip Scissors are extremely lightweight with plastic handles and stainless steel blades. The continuous loop handle automatically reopens the scissors when pressure is released. As they require only a gentle squeeze to operate them, they can be used between fingers and thumb or fingers and the palm of the hand. They are supplied with a blade guard for safe storage and are available with round or pointed blades in both right and left handed versions. The Mini Easi-Grip Scissors can be used either right or left handed and are ideal for both young children and those with restricted growth, plus for use when cutting threads, wool and fine craft work.

	Blade Length	Blade Style	Hand	Weight
081569664	45mm	Round End	Right	30g
091182617	45mm	Round End	Left	30g
081569672	45mm	Pointed	Right	30g
091102789	75mm	Pointed	Right	46g

Mini Easi-Grip Scissors

091102763	24mm	Round End	Both	16g
------------------	------	-----------	------	-----

3 Mounted Table Top Scissors

This device has scissors mounted on a plastic base, with rubber non-slip feet. The scissors are operated by depressing the "T" shaped handle and the spring will automatically reopen the blades once the pressure is released. Suitable for use by those with only one functional hand.

081584838	45mm Round Ended Blade
081584846	75mm Pointed Blade

4 Playing Card Holder

Designed for people with limited use of their hands. Cards can be easily added and removed. The front is extended to hold pencils or small coins. Height 35mm (1 3/8"). Length 250mm (10"). Width 50mm (2").

091105220

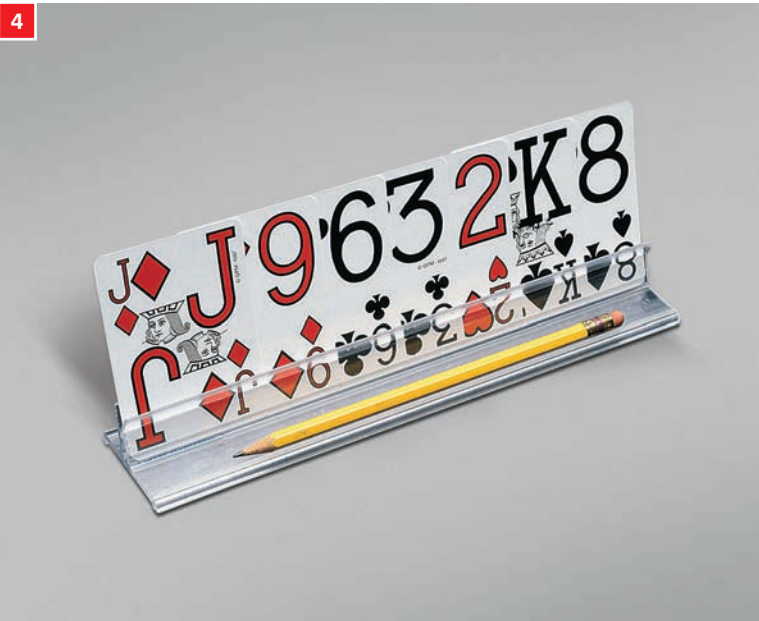
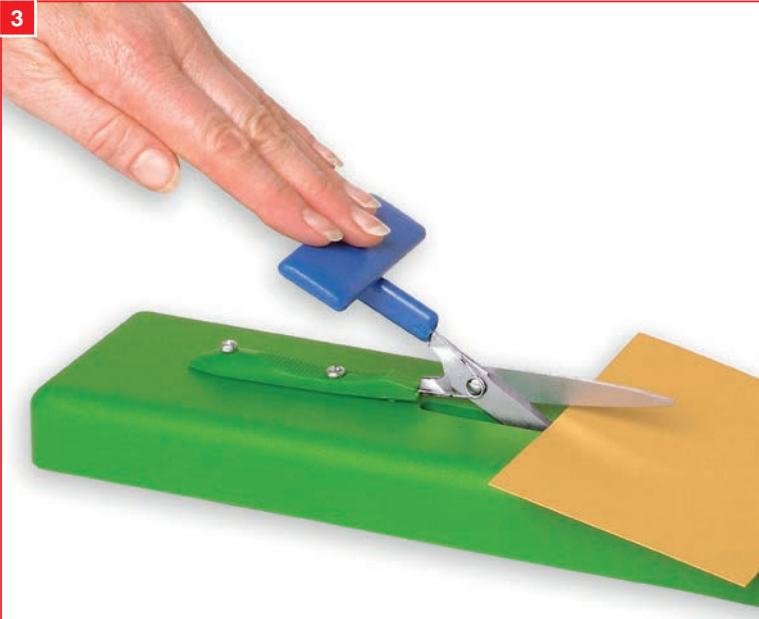

RETAIL PACKAGED
These products are supplied in retail packaging.