

Clinic Furniture

Couches & Plinths	328 - 338
Traction	339
Static & Portable Couches	340 - 341
Changing Tables	342
Tilt Tables	343 - 344
Paediatric Couches	345
Couch Rolls	346
Chairs & Stools	347 - 348
Trolleys & Cabinets	349
Screens & Mirrors	350
Arm Tables, Easels & Drip Stand	351
Work Tables	352 - 353
Steps	354
Stairs	355 - 357
Training Steps & Ramps	358
Parallel Bars	359 - 360
Suspension Frames, Wall Bars & Foot Rests	361
Pulleys	362

1



2 YEAR WARRANTY

1 Vision 2 Section Couch

- Twin lift design
- Electric and hydraulic models available
- Hand control operation on electric
- Positive/negative head section
- Clearance of 23cm for a mobile hoist
- Retractable wheels as standard
- Facility for fitting cot sides
- Facility for fitting paper roll holder
- Breathing hole and plug as standard
- Height Adjustment: 50 - 92cm (19 - 36")
- Head Section Adjustment: -20° - +80°
- Overall upholstery dimensions: Length 188cm (74") × Width 63cm (24.8")
- Head Section 63cm (24.8")
- Leg Section 125cm (49")

Table Measurements & Positions

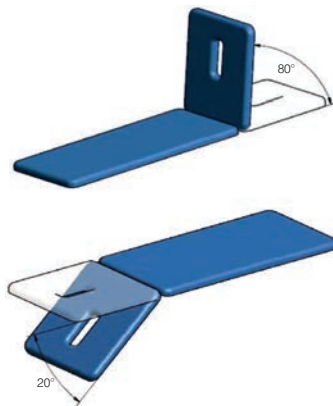
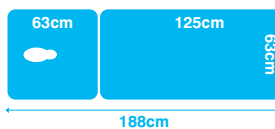

2 Section Electric

- 091526763** Dark Blue
- 091526771** Blue
- 091526789** Black

2 Section Hydraulic

- 091524925** Dark Blue
- 091524933** Blue
- 091524958** Beige

Optional Accessories:

- 091136688** Paper Roll Holder

Maximum user weight



MADE TO ORDER
This item is made to order and, therefore, is not refundable.

DELIVERY
Delivery is approximately 3 to 4 weeks. These items are shipped direct. Oversize items will be subject to additional carriage charges. See pages 790 to 792 for details. Please contact Customer Services for more information.



Colours are as accurate as the printing process will allow.



2 YEAR WARRANTY

1 Vision 3 Section Couch

- Twin lift design
- Electric & Hydraulic models available
- Hand control operation on electric
- Positive/negative head section
- Clearance of 23cm for a mobile hoist
- Retractable wheels as standard
- Facility for fitting cot sides
- Facility for fitting paper roll holder
- Breathing hole and plug as standard
- Height Adjustment: 50 - 92cm (19 - 36")
- Foot Section Adjustment: 0° to +80°
- Head Section Adjustment: -20° to +80°
- Overall upholstery dimensions:
Length 194cm (76.3") × Width 63cm (24.8")
- Head Section 63cm (24.8")
- Mid Section 54cm (21.2")
- Leg Section 77cm (30.3")

Table Measurements & Positions

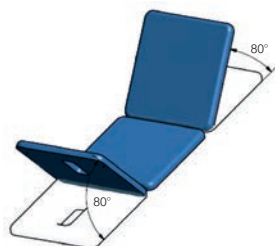

- 3 Section Electric**
- 091530575** Dark Blue
- 091530583** Blue
- 3 Section Hydraulic**
- 091524966** Dark Blue
- 091524974** Blue
- 091524982** Black
- 091524990** Beige
- Optional Accessories:**
- 091136688** Paper Roll Holder

Maximum user weight



Colours are as accurate as the printing process will allow.

MADE TO ORDER
This item is made to order and, therefore, is not refundable.

DELIVERY
Delivery is approximately 3 to 4 weeks. These items are shipped direct. Oversize items will be subject to additional carriage charges. See pages 790 to 792 for details. Please contact Customer Services for more information.

1



3 YEAR WARRANTY



1 Elite 2 Section Couch

- Twin lift design
- 4 Retractable wheels as standard
- Electric & Hydraulic models available
- Foot switch operation on electric
- Positive/negative head section: -30° to $+80^{\circ}$
- Clearance of 23cm for a mobile hoist
- Breathing hole and plug as standard
- Facility for fitting cot sides
- Facility for fitting paper roll holder
- Facility for fitting up/down surround bar
- Height Adjustment: 49 - 97cm (19.3 - 38.1")
- Available in two widths 60cm and 70cm
- Overall upholstery dimensions:
Length 200cm (78.7")
- Head Section 66cm (26")
- Leg Section 132cm (52")

Table Measurements & Positions

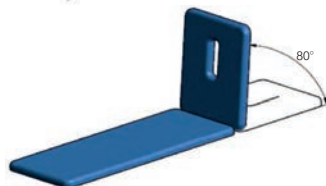
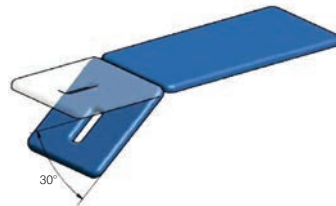
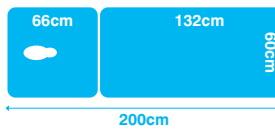

Electric 60cm	Hydraulic 60cm	
091441120	091441138	Balmain Blue
091516145	-	Black
091516152	-	Beige
Electric 70cm	Hydraulic 70cm	
091441146	091441179	Balmain Blue
091441112	-	Storm Grey
-	091441187	Beige

Optional Accessories:
091441625 Paper Roll Holder
091518737 Up/Down Surround Bar

Maximum user weight



Colours are as accurate as the printing process will allow.

DELIVERY
 These items are shipped direct. Oversize items will be subject to additional carriage charges. See pages 790 to 792 for details.



1 Elite 3 Section Couch

- Twin lift design
- 4 Retractable wheels as standard
- Electric & Hydraulic models available
- Foot switch operation on electric
- Positive/negative head section: -35° to $+80^{\circ}$
- Positive/negative foot section: -20° to $+35^{\circ}$
- Clearance of 23cm for a mobile hoist
- Breathing hole and plug as standard
- Facility for fitting cot sides
- Facility for fitting paper roll holder
- Facility for fitting up/down surround bar
- Height Adjustment: 49 - 96cm (19.3 - 38.1")
- Available in two widths 60cm and 70cm
- Overall upholstery dimensions:
Length 200cm (78.7")
- Head Section 65cm (25.6")
- Mid Section 67cm (26.4")
- Leg Section 65cm (25.6")

Table Measurements & Positions

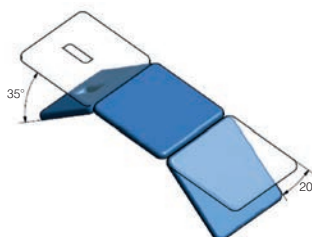
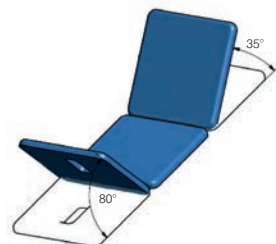
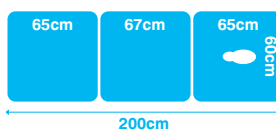

Electric 60cm	Hydraulic 60cm	
-	091441070	Balmain Blue
Electric 70cm	Hydraulic 70cm	
091441096	091441104	Balmain Blue
091516368	091516418	Black
091516376	-	Storm Grey
091516350	-	Beige

Optional Accessories:

- 091441625** Paper Roll Holder
- 091518737** Up/Down Surround Bar

Maximum user weight



Colours are as accurate as the printing process will allow.

DELIVERY
These items are shipped direct. Oversize items will be subject to additional carriage charges. See pages 790 to 792 for details.



3 YEAR WARRANTY

1 Elite Aster Couch

- Suitable for heavy manipulation with the top section completely supported by a steel frame
- Elongated breathing hole for patient positioning including paediatrics
- 4 Retractable wheels as standard
- Electric & Hydraulic models available
- Foot switch operation on electric
- Positive/negative head section: -75° to $+20^{\circ}$
- Rising backrest from horizontal to 88°
- Clearance of 23cm for a mobile hoist
- Facility for fitting cot sides
- Facility for fitting paper roll holder
- Facility for fitting up/down surround bar
- Height Adjustment: 50 - 96cm (19.7 - 37.8")
- Available in two widths 60cm and 70cm
- Overall upholstery dimensions:
Length 194cm (76.3")
- Head Section: 40cm (15.7")
- Mid Section: 66cm (26")
- Leg Section: 84cm (33")

Table Measurements & Positions

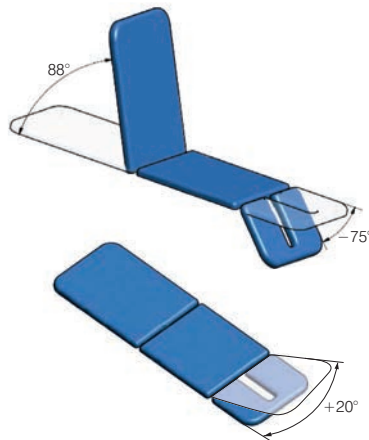
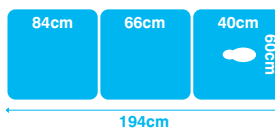

Electric 60cm	Hydraulic 60cm	
091441195	091441203	Balmain Blue
091516467	091516483	Storm Grey
091516459	091516475	Beige
Electric 70cm	Hydraulic 70cm	
091441229	-	Balmain Blue

Optional Accessories:

091441625	Paper Roll Holder
091518737	Up/Down Surround Bar

Maximum user weight



Colours are as accurate as the printing process will allow.

DELIVERY
These items are from stock. Oversize items will be subject to additional carriage charges. See pages 790 to 792 for details.

metron™ ELITE



HEAVY DUTY **3 YEAR WARRANTY**

1 Bariatric Couch

- 4 Retractable wheels as standard
- Hand control operation
- Positive/negative head section: -30° to $+80^{\circ}$
- Positive/negative leg section: -30° to $+80^{\circ}$
- Clearance of 23cm for a mobile hoist
- Facility for fitting paper roll holder
- Height adjustment: 50 - 97cm (19.7 - 38.2")
- Fail safe backrest locking mechanism
- Standard motorised backrest
- Hard wearing antimicrobial vinyl

Table Measurements & Positions

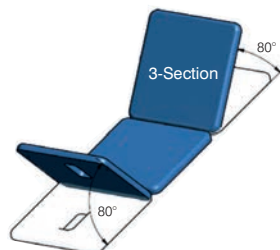
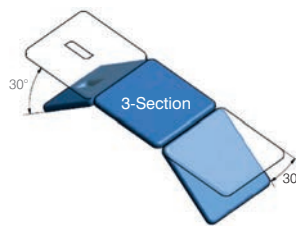
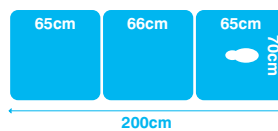

3 Section

- Overall upholstery dimensions: Length 200cm (78.7") \times Width 70cm (27.5")
- Head Section 65cm (25.6")
- Mid Section 66cm (26")
- Leg Section 65cm (25.6")

091441286 Balmain Blue

Optional Accessories:

091441625 Paper Roll Holder

Maximum user weight

249 kg **39 st**



BALMAIN BLUE

Colours are as accurate as the printing process will allow.

DELIVERY These items are from stock. Oversize items will be subject to additional carriage charges. See pages 790 to 792 for details.

shown with optional
UP/DOWN SURROUND BAR



3 YEAR WARRANTY



1 Elite 7-Section (Motorised)

The drop down shoulders allow the therapist to position themselves closer to their client and conduct their treatment without excessive leaning and straining of their own back etc. All lift up sections are controlled by quality gas struts.

- Lift up and tilt down head section
- Lift up backrest
- Lift up centre section (electric) (postural drainage version only)
- Unique massage chair head rest design
- Movable arm rests & drop down shoulders
- 4 Retractable wheels as standard
- Hand control operation on electric
- Positive/negative head section -30° - +80°
- Breathing hole and plug as standard
- Facility for fitting up/down surround bar
- Height adjustment: 49-97cm (19.3 - 38.1")
- Available in two widths
- Max user weight: 205Kg (32st)
- Overall upholstery dimensions:
Length 200cm (78.7") x Width 60cm (23.6")
- Head Section 40cm (15.7")
- Mid Section 66cm (26")
- Leg Section 89cm (35")

Table Measurements & Positions

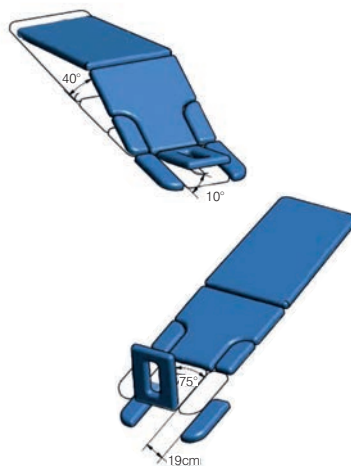
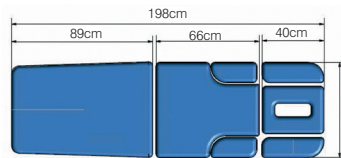

60cm **With Postural Drainage**

091441328 Balmain Blue

Optional Accessories:

091441625 Paper Towel Holder & Roll

091518737 Up/Down Surround Bar

Maximum user weight

249 kg **39 st**



BALMAIN BLUE

Colours are as accurate as the printing process will allow.

DELIVERY

These items are from stock. Oversize items will be subject to additional carriage charges. See pages 790 to 792 for details.



3 YEAR WARRANTY

1 Elite Neurology Couch

- Designed for the treatment of patients suffering from neurological conditions
- Large upholstered top allowing exercise movements to be performed with room both for the patient and the therapist
- Height Adjustment: 46 - 89cm (18 - 35")
- Suitable for patient transferring and standing exercises
- Smooth lifting action is achieved by the electric actuator which is controlled via a hand set
- The back section can be adjusted safely and effortlessly using high quality gas struts
- Easy hoist/patient lifter access as standard
- Available in two widths
- Positive/Negative Head Section: -30° to 80°
- Overall upholstery dimensions: Length 208cm (81.9")
- Head Section: 65cm (25.6")
- Leg Section: 140cm (55.1")

Table Measurements & Positions

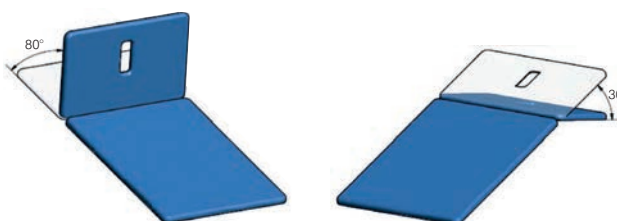
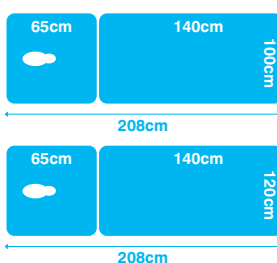

- 100cm Width
091516285 Balmain Blue
- 120cm Width
091441567 Balmain Blue
- Optional Accessories:**
091441625 Paper Roll Holder

Maximum user weight **249 kg** **39 st**



Colours are as accurate as the printing process will allow.

DELIVERY
These items are from stock. Oversize items will be subject to additional carriage charges. See pages 790 to 792 for details.



2 YEAR WARRANTY

1 Vision Neurology Couch

- Twin lift design
- Electric & Hydraulic models available
- Hand control operation on electric
- Rising head section 0 to +90
- Clearance of 23cm for a mobile hoist
- Suitable for postural exercise and Bobath techniques
- Facility for fitting cot sides at point of order
- Breathing hole and plug available as optional extra
- Height Adjustment: 50 - 92cm (19 - 36")
- Max User Weight: 225kg (35.7st)
- Overall upholstery dimensions: Length 194cm (74") × Width 102cm (40")
- Head Section: 63cm (24.8")
- Leg Section: 125cm (49")
- 2 Year Warranty

Table Measurements & Positions

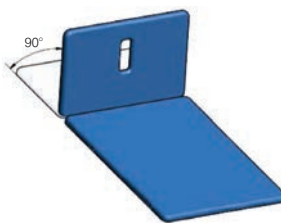
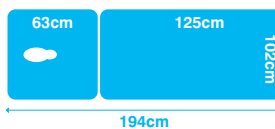

Electric

- 091134444** Dark Blue
- 091134410** Blue
- 091134428** Black
- 091134436** Beige

Hydraulic

- 091134485** Dark Blue
- 091134451** Blue
- 091134469** Black

Optional Accessories:

- 091191782** Padded Drop Down Cot Sides (Pair)

Maximum user weight



Colours are as accurate as the printing process will allow.



DELIVERY

Delivery is approximately 3 to 4 weeks. These items are shipped direct. Oversize items will be subject to additional carriage charges. See pages 790 to 792 for details.



MADE TO ORDER

This item is made to order and, therefore, is not refundable.

**1 Podiatry/Examination Chair MK1**

- Minimum Height: 53cm/20.9"
- Maximum Height: 95cm/37.4"
- Cushion Width: 55cm/21.7"
- Head Section Length: 74cm/29"
- Mid Section Length: 48cm/18.9"
- Leg Section Length: 50cm/19.7"
- Total Length (with Tray): 202cm/79.5"
- Head Tilt Angle: 0°/80°
- Mid Tilt Angle: 0°/15°
- Leg Tilt Angle: -40°/15°
- Breathing Hole: 1
- Retractable Wheels: Standard × 4
- User Weight Rating: 205kg/451lb

091441393 BlackMaximum
user weight**DELIVERY**

Delivery is approximately 3 to 4 weeks. These items are shipped direct. Oversize items will be subject to additional carriage charges. See pages 790 to 792 for details.

**MADE TO ORDER**

This item is made to order and, therefore, is not refundable.

1



1 Homecraft Mat Platform

Designed to accommodate a variety of therapeutic treatments that require extra width and a greater working surface.

- Twin lift design
- Constructed from robust steel for maximum stability and strength
- Electric and hydraulic models available
- Hand control operation on electric model
- Clearance of 23cm for a mobile hoist
- Height adjustment 50 - 92cm (19 - 36")
- Upholstery dimensions: Length 186cm (73"). Width 125cm (49").

091136365 Electric Blue UK Plug

Maximum user weight

225 kg **35 1/2 st**



2 Low Wide Exercise Table

An extra wide, low, fixed height exercise table that provides a greater range of movement and safety. Supplied in beige, flame retardant vinyl upholstery. Supplied flat packed. Height 46cm. Length 183cm. Width 92cm. Weight 38kg.

091137025

Maximum user weight

140 kg **23 st**



2



2



NEXT DAY DESPATCH

Delivered from stock, orders received before 3pm are despatched the next day. Oversize items will be subject to additional carriage charges. See pages 790 to 792 for details.



DELIVERY

Delivery is approximately 3 to 4 weeks. These items are shipped direct. Oversize items will be subject to additional carriage charges. See pages 790 to 792 for details.



MADE TO ORDER

This item is made to order and, therefore, is not refundable.



3 YEAR WARRANTY

1 Elite Traction Couch

- Height Adjustment: 55 - 101cm (21.7" - 39.8")
- Positive /negative head section: -40° to +30°
- Rising leg section from horizontal to 90°
- Head Section Length: 40cm (15.7")
- Mid Section Length: 41cm (16") and 26cm (10")
- Leg Section Length: 91cm (35.8")
- 2 No. Retractable wheels as standard
- Breathing hole and plug as standard
- Overall Length: 202cm (79.5")
- Width: 60cm (23.6")
- Traction Pole
- Adjustable Mounting Angle: 0° / -20°
- Pole Rotation Angle: 180°

Table Measurements & Positions

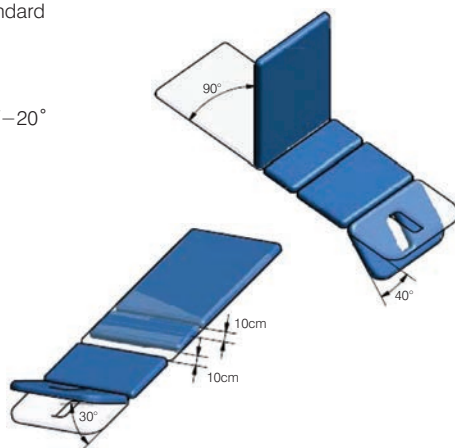

Electric

091441419 Balmain Blue

091516111 Beige

Optional Accessories:

091441625 Paper Roll Holder

091518737 Up/Down Surround Bar

091515469 Thoracic Traction Belt (2 D-Linkage Points)

091515451 Pelvic Traction Belt (1 D-Linkage Point)

091515436 Traction Straps (x2) Thoracic Belt

Maximum user weight



Colours are as accurate as the printing process will allow.

DELIVERY
These items are delivered from stock. Oversize items will be subject to additional carriage charges. See pages 790 to 792 for details.

1



3 YEAR WARRANTY



SHOWN WITH OPTIONAL DRAWER UNIT



Colours are as accurate as the printing process will allow.

1 Colenso Examination Couches

The Colenso examination couch is exceptionally stable, durable and comfortable for the client. Optional drawer unit available.

Features:

- Multi-position self locking adjustable backrest
- Stylish 60mm diameter legs improves stability
- Flame retardant upholstery (BS5852)
- Paper roll holder included (Fits at head or foot end)
- British made
- CE marked

Dimensions: Height 79cm. Length 183cm. Width 60cm.

091158112 Black

091158120 Blue

091158138 Grey

Maximum user weight



2 Affinity Portable Flexible Table

The portable/flexible massage table can be used for a wide variety of treatments. It features a 75° lifting head section, sturdy construction and removable breathing hole have quickly established this table as one of the best in the market. Specially shaped end plates allow excellent access at either end. Comfortable "Therafoam" cushioning system gives support and comfort even during long treatments. Height adjustable from 63-81cm, can be adjusted using the "Easi-turn" knobs which are easy to grip.

Features:

- 10 position lifting back rest
- Rapid set up reducing delay between appointments or allowing your treatment room to be used for other purposes
- Durable double backed PVC upholstery resisting nicks and tears for years of continued use
- Triple-ply "Therafoam" 50mm rated semi-firm for sports and remedial massage
- Foam-filled high strength luxury carry handles, for improved portability
- Free two year warranty on this item covering, frame, base and factory faults on the vinyl
- Carry case included as standard

Dimensions: Length 185cm. Width 68cm. Weight 16.8kg.

091422997 Biscuit

Maximum user weight



2



1 Affinity Marlin Portable Table

A truly portable couch at only 14.5kgs. With a one touch height adjustment feature, this aluminium table is designed to be put up quickly, used and taken to the next appointment, with the minimum of strain and difficulty for the therapist. It is exceptionally rigid, can take large clients without fuss, and its lifting head section enables the most beneficial position for the client and therapist. Height adjustable from 58-81cm, precise telescopic legs allow the height to be adjusted rapidly whilst still retaining the stability required for high impact treatments.

Features:

- 10 position lifting back rest
- Rapid set up reducing delay between appointments
- Durable double backed PVC upholstery resisting nicks and tears for years of continued use
- Triple-ply "Therafoam" 50mm rated semi-firm for sports and remedial massage
- Foam-filled high strength luxury carry handles
- 450lb impact strength (32st dropped from 7") plus high strength when force is applied across the table (lateral movement)
- Carry case included as standard
- Dimensions: Length 185cm, Width 63cm
- 2 year warranty

091274729 Portable Couch

Maximum user weight

226 kg **35½ st**



2 Terry Towelling Couch Covers

The highest quality couch covers with breathing holes. Designed to fit most popular makes of couch.

With Breathing Hole

091218221 Navy Blue

3 Face Savers

Many patients find lying in the prone position both uncomfortable and claustrophobic. Face Savers are soft and comfortable, and when placed over the breathing hole, they allow the patient to lie with the forehead and cheeks on the saver and relax and breathe easily.

This compact product is manufactured from polyurethane foam and comes complete with looped fleece cover, removable for laundering. Additional covers available to match couch covers.

091280486 Standard Foam

091280593 Memory Foam

091210459 Cover - Navy Blue



10 POSITION LIFTING BACK REST



ROUNDED CORNERS



2



3



homecraft

1 Homecraft Paediatric Changing Table

The paediatric table is brightly coloured making it fun for children and aiding compliance. It is strong and robust and has a two-year guarantee.

- Hand switch control on electric model
- Retractable wheels
- 16cm clearance for mobile hoist
- Padded cot sides as standard

Length 150cm (59"). Width 70cm (27"). Width including outside 85cm (33"). Height adjustment 44 - 86cm (17 - 33"). Max overall length when lowered 182cm (71"). Recommend a manoeuvrability clearance of 160cm (63") is allowed.

- 091135011** Electric UK Plug
- 091158104** Electric EU Plug
- 091158096** Hydraulic

Maximum user weight



2 Homecraft Universal Changing Table

This changing table has excellent manoeuvrability due to retractable wheels and can be fitted with cot sides for patient safety. It features a strong, robust design and a two-year guarantee.

- Hand switch control on electric model
- Retractable wheels
- 23cm clearance for mobile hoist

Length 182cm (71"). Width 70cm (27"). Height adjustment 50 - 92cm (19 - 36").

- 091134824** Hydraulic
- 091164250** Electric EU Plug
- 091191782** Cot Sides

Maximum user weight



homecraft

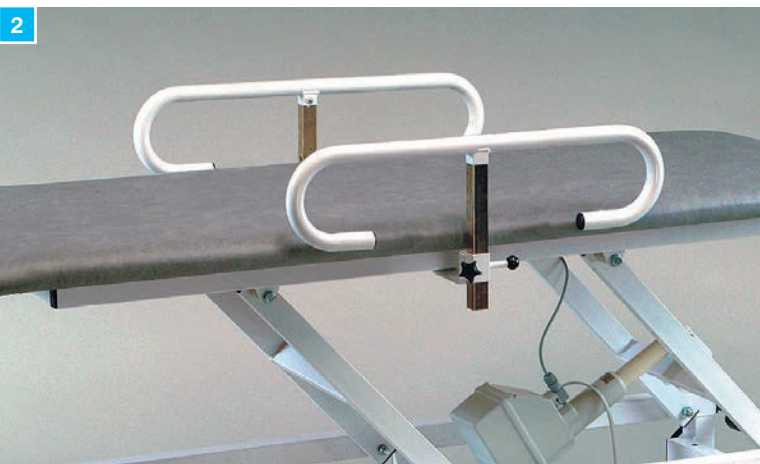

DELIVERY
Delivery is approximately 4 to 5 weeks. These items are shipped direct. Oversize items will be subject to additional carriage charges. See pages 790 to 792 for details.

MADE TO ORDER
This item is made to order and, therefore, is not refundable.

**3 YEAR
WARRANTY**

1 Variable Height Tilt Table

- Minimum Height: 51cm/20"
- Maximum Height: 86cm/33.9"
- Cushion Width: 65cm/25.6"
- Leg Section Length: 190cm/74.8"
- Total Length (+ Footplate): 200cm/78.7"
- Lift Mechanism: Electric
- Breathing Hole: 0
- Wheels: 4 Braked
- Tilting Mechanism: Electric
- User Weight Rating: 205kg/451lb
- Supplied with set of 3 straps

Table Measurements & Positions

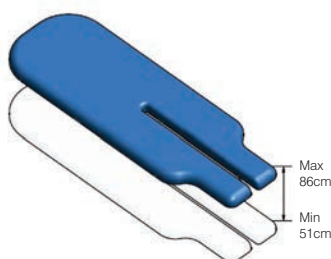
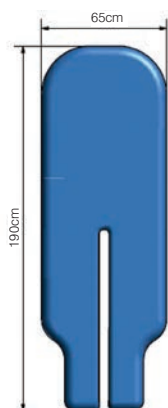

- 091441559** Balmain Blue
- Optional Accessories:**
- 091433531** Extra Set of Straps
- 091433564** Activity Tray
- 091433572** Single Footplate

Maximum
user weight

**BALMAIN
BLUE**

Colours are as accurate as the printing process will allow.



DELIVERY

These items are shipped from stock. Oversize items will be subject to additional carriage charges. See pages 790 to 792 for details.



1 Homecraft Electric Adult Tilt Table

An economical tilt table that includes some outstanding features. Manufactured to a very high standard, it represents exceptional value for money. Tilt tables are used extensively in functional rehabilitation where the requirement to stand or be upright is of paramount importance. Standing can improve quality of life, assist in the natural gravitational functions of the body, re-educate balance mechanisms affected by long periods of lying and give a degree of independence. The design of this tilt table also means that the footboard can be removed so it can be used as a plinth featuring a negative head section and breathing hole with plug. With an extremely smooth movement, this tilt table is designed to promote confidence in both the client and the therapist.

Features

- Smooth electric tilt operation
- 0 to 90° tilt adjustment
- Four large braking castors for safety and ease of movement
- Three straps for added client safety
- Side handles to promote client confidence
- Worktable as standard
- Flame retardant upholstery
- Steel frame with powder coated finish for strength and durability

Height 71cm. Length 183cm. Width 60cm.

- 091135771** Blue UK Plug
- 091135813** Beige UK Plug
- 091135839** Dark Blue UK Plug
- 091135763** Blue EU Plug
- 091201755** Replacement Tilt Table Straps - Set of 3

Maximum user weight



2 Homecraft Electric Paediatric Tilt Table

This electric tilt table has been especially designed for children, catering for a number of treatment requirements to improve the quality of life for the smaller patient. Brightly coloured in blue and red vinyl to promote compliance, it also features an adjustableommel and pelvic supports to improve confidence for both the child and the therapist.

Features

- Electric tilt operation
- 0 to 90° tilt adjustment
- Four large braking castors for safety and ease of movement
- Height adjustable footboard andommel
- Adjustable pelvic supports
- Flame retardant, brightly coloured upholstery
- Steel frame with powder coated finish for strength and durability

Height 65cm. Length 137.5cm. Width 50cm.

- 091135854** UK Plug

Maximum user weight



3 Accessories

Not Illustrated

A number of accessories are available that cater for users who require additional support during tilt table procedures. These accessories must be specified at the time of ordering.

- 091136886** Replacement Fixation Belts - Set of 3
- 091136860** Adjustable Height Pommel*
- 091352368** Dewert Multi-Voltage Transformer Inc Mains Lead UK,EU & USA
- 091339746** Fixation Belt 3.5m Long - Black

*The split leg version must be ordered for the fixation of these accessories.

DELIVERY
Delivery is approximately 4 to 6 weeks. These items are shipped direct. Oversize items will be subject to additional carriage charges. See pages 790 to 792 for details.

MADE TO ORDER
This item is made to order and, therefore, is not refundable.

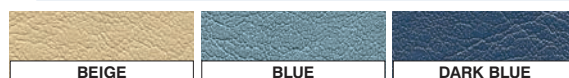

Colours are as accurate as the printing process will allow.



2 YEAR WARRANTY

ELECTRIC VERSION SHOWN

1 Paediatric Couch

This paediatric two section couch is brightly coloured making it fun for children and aiding compliance.

- High quality 2 section universal couch
- Twin lift design
- Electric and hydraulic models available
- Hand control operation on electric model
- Positive/negative head section from -20° to +90°
- Mobile hoist clearance 16cm
- Breathing hole and plug
- Height adjustment 50 - 92cm
- Padded cost sides as standard
- Upholstery: Length 188cm (74") Width 65cm (25")

091201110
091441591

Electric
Hydraulic

Maximum user weight



DELIVERY
Delivery is approximately 4 to 5 weeks. These items are shipped direct. Oversize items will be subject to additional carriage charges. See pages 790 to 792 for details.

MADE TO ORDER
This item is made to order and, therefore, is not refundable.



1 Economy Couch Rolls

- In 10" (25cm) width
 - 40m per roll
 - Available in white only
- 091181429** 10" White Case of 24

2 10" Progena Wiper Rolls

- 10" (25cm) width
 - 40m per roll
 - Available in white or blue
 - Premium quality 2 ply tissue
 - Easy tear perfect perforations
 - 100% pure paper sourced from managed forests
- 091365436** White Case of 18
091365428 Blue Case of 18

3 20" Progena Wiper Rolls

- 20" (50cm) width
 - 40m per roll
 - Available in white or blue
 - Premium quality 2 ply tissue
 - Easy tear perfect perforations
 - 100% pure paper sourced from managed forests
- 091365394** White Case of 9
091365360 Blue Each
091365378 Blue Case of 9

4 Couch Rolls

- 20" width
 - 9 or 12 rolls per case
 - 40m per roll
 - 100 sheets per roll
 - White and blue available
 - 2 ply tissue
- 091364207** 20" (50cm) White 12/case
091364223 20" (50cm) Blue 12/case
091555952 20" (50cm) White 9/case

5 20" Luxury Embossed Wiper Rolls

- 20" (50cm) width
 - 32m per roll
 - Bright white in colour
 - Premium quality 2 ply tissue
 - Easy tear perfect perforations
 - 100% pure paper sourced from managed forests
- 091365345** White Each
091365352 White Case of 9

6 Couch Roll 10" Luxury Embossed

- Premium quality 2 ply tissue. Easy tear perfect perforations.
- 10" (25cm) width
 - 32m per roll
 - 18 cases
 - Bright white in colour
 - Premium quality 2 ply tissue
 - Easy tear perfect perforations
 - 100% pure paper sourced from managed forests
- 091365311**

7 Table Exam Paper

- The Dynarex table paper prevents cross-contamination between patients in doctor's office or examination room. This quality table paper offers superior performance and economy. It is available in smooth or crepe finish.
- 12 rolls per case - 8" x 125'
- 081616986** White

1 Gas Lift Operators Chair

A comfortable operators chair with a thick padded seat and back covered in durable wipe clean upholstery. The five-point base with castors aids manoeuvrability. Gas-lift, seat height is adjustable from 42 to 57cm. Seat 46cm wide x 43cm deep. Base diameter 60cm.

- 091134311** Black
- 091134360** Black with Arms
- 091134394** Sky Blue with Arms

Maximum user weight



2 Affinity Saddle Stool

Offers the therapist a much improved seated posture thereby minimising workplace injury. Seat size 43x40cm. Foam padding 7cm. Height range 32 to 66cm. Available in two colours.

- 091428721** Navy Blue
- 091428747** Black

3 Affinity Puma Massage Chair

The Affinity Puma sets new standards in style, portability and adjustment. Silent even under lateral movement, the Puma sets up in seconds.

Features

- Sets up quickly and easily
- Perfect proportions 74cm x 54cm x 120-136cm
- Compact portable design.
- Lightweight 7kgs.
- 3-position armrest 3-position seat adjustment.
- Adjustable face cradle. Chest pad is adjustable. Sternum pad supplied free. Ergonomic shaped cushioning.
- Sleek, strong, aerodynamic frame 2" (5cm) 3-ply of Therafoam for optimum comfort. Strong and silent even under lateral movement 300lbs dynamic strength
- 2-year warranty.

091364199

4 Pneumatic Wheelie Stool

A height adjustable wheelie stool with swivel castors for easy mobility when sitting. Made from high density thick foam with a wipe clean vinyl seat. Colours may vary. Seat height adjusts from 41 to 54cm. Seat diameter 46cm. Diameter of base 56cm.

091136662

Maximum user weight



5 Gas-Lift Examination Stool

This high quality gas-lift stool features a deluxe comfortable padded seat with anti-bacterial upholstery. The five castors offer stability and ease of manoeuvrability. The seat is adjustable from 42 to 58cm. Seat diameter 37cm, base diameter 60cm.

091157320 Black

Maximum user weight



6 Affinity Rolling Stool

This gas lift stool is excellent value and extremely comfortable. Available in two colours. The seat is adjustable from 43 to 56.5cm. Seat diameter 39cm, base diameter 56cm. Foam padding 10cm. Upholstered in PVC vinyl.

- 091274737** Biscuit
- 091274778** Navy Blue

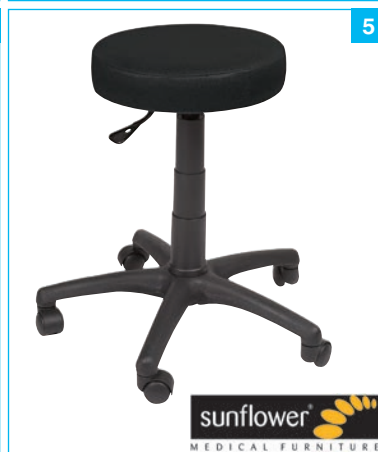
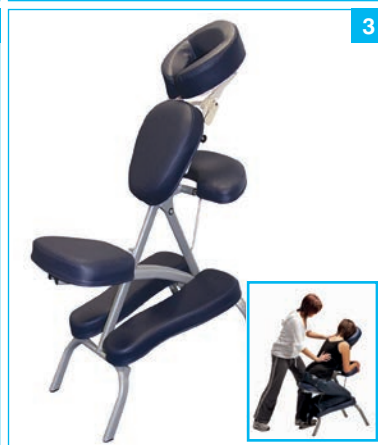
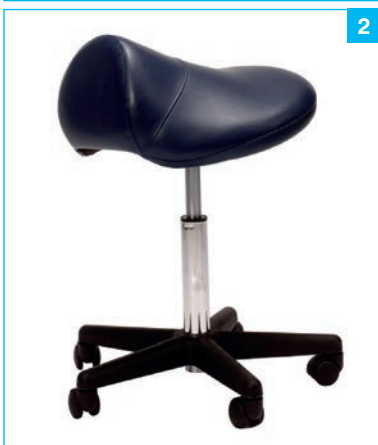

DELIVERY

Delivery is approximately 4 to 6 weeks. These items are shipped direct. Oversize items will be subject to additional carriage charges. See pages 790 to 792 for details.



MADE TO ORDER

This item is made to order and, therefore, is not refundable.

1



BEST SELLER

homecraft

1 Homecraft Adjustable Therapy Benches

These Adjustable Therapy Benches are ideal for use by therapists or parents when working with children who do not need back support but need a seat that can be adjusted so that their feet rest on the floor. The height is easy to adjust and the seat can be tilted, which places more weight on the child's feet and aids postural control. Available in two sizes.

	Width	Length	Height
091207232 Small	27cm	66cm	18-28cm
091207240 Large	36cm	80cm	27-43cm

Maximum user weight

100 kg **15³/₄ st**

2 Homecraft Mobile Therapy Stool

This Therapy Stool is designed for use by therapists, teachers or parents. The stool has a padded seat with a colourful vinyl covering. The height is adjustable from 34-46cm (13-18") and the stool has lockable castors for added security. Measures 45x37cm (17³/₄x14¹/₂"

091206887

Maximum user weight

100 kg **15³/₄ st**

2



BEST SELLER

homecraft

3 Therapy Benches

These therapy benches have adjustable height and are designed to angle along or across the bench surface. They are available in three sizes and two widths. The ends have a side slot for easy, safe and positive adjustment.

	Short	Height	Length	Width
091108323	195-295mm	610mm	250mm	
091108331	195-295mm	610mm	300mm	
Medium				
091108349	280-455mm	820mm	300mm	
091108356	280-455mm	820mm	380mm	
High				
091108364	415-705mm	820mm	325mm	
091108372	415-705mm	820mm	380mm	

3



4 Wheely Therapy Stool

Designed for use by therapists, teachers and parents when working at floor level with children. They are adjustable in height to suit the individual and for stability. They should be used by sitting astride the narrower side.

Available with a red seat or a green seat. Height 340-460mm (13 to 18"). Length 450mm (17¹/₂"). Width 370mm (14¹/₂").

091108240 Red
091108257 Green

4



£ PRICES
For up-to-date prices please see our Website, alternatively contact your Sales Representative or Customer Services.

1 Economy Trolley

This trolley features three 40x50cm shelves, all with a lip to prevent items from falling off. It has a hardwearing white finish and two of the castors are braked. Height 69cm.

091134675



2 Stainless Steel Trolleys

These stainless steel utility trolleys are constructed from heavy duty, polished stainless steel. All shelves feature thick, 22 gauge steel shelves with double thick 16 gauge legs. 360° rotating castors are standard on all models. Holds up to 135kg.

Three-Shelf Trolley with Handle

091019843 Width 61cm. Depth 40.6cm.
Height 81.3cm



3 Gym/Equipment Trolley

A durable and practical storage trolley for large or awkward equipment. Made from epoxy coated steel with castors for easy manoeuvrability. Length 127cm. Width 66cm. Height 106cm.

091136548



4 Sunflower Multi-Purpose Trolley

Features a removable clear tray with new tilting and locking runner system incorporating a label and cover and an adjustable shelf with two height settings. The white epoxy coated frame offers durability and ease of cleaning. Twin wheel castors aid movement. Width 56cm. Depth 52cm. Height 101cm.

091133347



5 Sunflower Lockable Cabinets

Lockable cabinets conform to both the Misuse of Drugs (Safe Custody Regulation) 1973 and exceed British Standard BS 2881:1989 Security Level 1. The locking mechanism complies with BS 3621:1998 so keys cannot be removed if left open and it has more than 1000 combinations. They are constructed from 16 gauge steel with hardened hinges for security.

	Height	Width	Depth
091157296	85cm	60cm	30cm



SAME DAY DESPATCH
Delivered from stock, orders received before 4pm are despatched the same day. Oversize items will be subject to additional carriage charges. See pages 790 to 792 for details.

DELIVERY
Delivery is approximately 2 weeks. These items are shipped direct. Please contact Customer Services for more information.





SHOWN WITH BLUE SCREEN KIT PANELS

1 Doherty Panel Screen System

The Doherty Panel Screen system is designed to provide a modern alternative to traditional curtain screens.

- Easy to clean hygienic construction with high specification fire retardant plastic panels
- Panels cover full frame of screen for complete privacy
- 4 panels per kit supplied with all required fastenings and fitting instructions

Dimensions: 168×224cm (fully extended) 168×61cm (closed)

091357888 Frame Only (white epoxy)

2 Sunflower Mobile Folding Screens

- Quality, hygienic easy to clean panels
- Flame retardant panels
- White epoxy coated frame for durability and ease of cleaning
- Minimal assembly required
- Available in a range of colours
- Available in three, four or five panels
- 2 year guarantee

Three section: Length 188cm. Width 48cm. Height 172cm.

Four section: Length 250cm. Width 48cm. Height 172cm.

Five section: Length 312cm. Width 48cm. Height 172cm.

	3 Panel	4 Panel	5 Panel
White	-	091133727	091133784
Patchwork Blue	-	091133693	-
Sky Blue	-	091322510	-
Bubbles	091358290	-	-
Silver	-	091358357	091358381
Mr. Men	-	-	091322536



2 YEAR GUARANTEE

WHITE

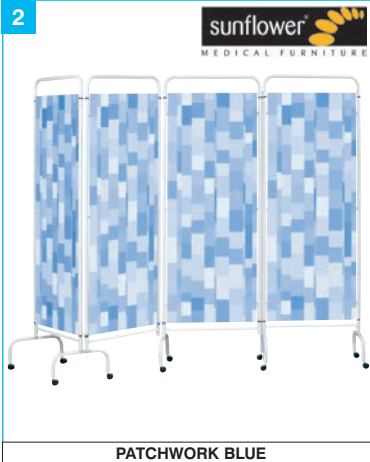

PATCHWORK BLUE

3 Sammons Preston Glass Mirrors

For educational and therapy programmes where a reflective glass surface is preferred. Heavy plate glass with electroplated copper produces bright, distortion free images. Oak laminate frame provides an attractive appearance. The single section mirror and each panel of the three section mirror measure 69cm wide and 183cm high and may be locked into position. Both mirrors include brackets for mounting to a wall, and castors for a free standing unit.

081034313 Single Section

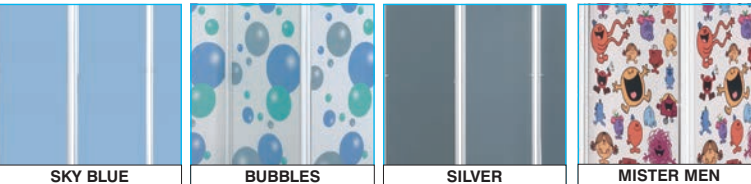

SKY BLUE

BUBBLES

SILVER

MISTER MEN

4 Posture Mirrors

Posture mirrors can be used for postural re-education and feedback for normal movement. Glass is bonded to laminate for added safety. Available on a hinged frame with castors for easy manoeuvrability and adjustability or as a wall mounted mirror. Panel size 120×36cm.

091139674 Mobile

091139682 Wall Mounted



SammonsPreston



SAME DAY DESPATCH
Please contact Customer Services for more information.

DELIVERY
Delivery is approximately 4 to 6 weeks. These items are shipped direct. Please contact Customer Services for more information.

1 Adjustable Arm Table

An extremely comfortable, padded arm table, which tilts across a range of angles and rotates on a set of braked castors. Particularly useful during evaluation and rehabilitation. Length 60cm. Width 30cm. Height adjustable from 75cm to 115cm.

091138296 Black

2 Arm Table

A strongly constructed hardwood arm table made from beech with a Formica top. Length 61cm. Width 30cm. Height 71cm.

091136589

3 Tilting Easel

This high quality tilting easel transforms a standard flat table into a tilting work surface. Can be used at any angle from horizontal to vertical. A lip at the bottom of the easel supports most activity boards and is removable to give a flat surface. Height 70cm. Length 70cm.

091138304

4 Days Deluxe Drip Stand

A deluxe drip stand with a low centre of gravity and a maximum load weight of 10kg. The height can be adjusted from 1170 to 2030mm (46 to 80") to accommodate different users and environments. Supplied with anti-static manoeuvrable castors.

Height adjustment 1170 to 2030mm (46 to 80").

Maximum load 10kg.

091439017



1



2



3



4

days

1



homecraft

2



1 Homecraft Universal OT Table

A work table for general occupational therapy use with an adjustable angle laminated work surface and a variable height.

- Hand switch control on electric model
- Large locking castors for mobility
- Optional knee block and standing harness
- Wheelchair cut-out

Dimensions: Height 50-92cm. Length 152cm. Width 70cm.

091134691 OT Table - Hydraulic

091134683 OT Table - Electric

091134493 Padded Knee Block & Standing Harness



2 Treatment Table

This height adjustable treatment table features a scratch resistant grey laminate top with wheelchair cut-out. The top angles from 0° to 45° and the height of the table is adjustable from 74 to 112cm. Top measures 19×76×107cm. A 6.4mm raised metal edge round the table top prevents items from sliding off. Folds easily for storage when not in use. Weight 19kg. Washable.

081301712

DELIVERY

Delivery is approximately 4 weeks. These items are shipped direct. Oversize items will be subject to additional carriage charges. See pages 790 to 792 for details.

1



1 SKM Easywind™ Tilt Table 900mm

The Activity Easywind Tilting Table is an incredibly flexible, height adjustable table. It features a stainless steel basin that can be used for water play with a lockable timber infill for when the basin is not in use. The table has an adjustable angled surface with lip, and twin wheels that lock, ensuring that the table will not slip or pivot, leaving the user free to concentrate on the activity at hand. Available in standard versions. Tilt 0° to 70°.

Height Adjustment

091134741	Standard	60-86cm (Wheels)
091320639	Standard	52-78cm (Glides)



1

DELIVERY
 Delivery is approximately 4 to 6 weeks. These items are shipped direct. Oversize items will be subject to additional carriage charges. See pages 790 to 792 for details.

MADE TO ORDER
 This item is made to order and, therefore, is not refundable.



1 Step Stool

A simple, sturdy stool consisting of a chrome plated steel frame with a non-slip rubber mat. Rubber ferrules provide good grip on slippery surfaces. Top area 28×36cm. Base area 30.5×41cm. Height 22.5cm.

091102680

Maximum user weight



2 Step Stool with Handrail

A sturdy stool with chrome plated steel frame. The stool has a non-slip textured mat on the surface. The rail, attached to one side of the step, helps to give the user extra confidence and stability. Rubber ferrules provide good grip on slippery surfaces. Top area 28×36cm. Base area 30.5×41cm. Height 22.5cm.

091102698

Maximum user weight



3 Double Tier Couch Step

This couch step is the double tier version of the couch step above and features all the same high quality characteristics. Width 57cm. Depth 48cm. Height 40cm.

091133644

Maximum user weight



£ PRICES
For up-to-date prices please see our Website, alternatively contact your Sales Representative or Customer Services.



1 Homecraft Conventional Steps

These high quality conventional steps feature three steps on one side and four on the other. On the side with three, the steps are 20cm deep and on the side with four, they are 15cm deep. The handrails are independently height adjustable from 40 to 90cm. Footprint: 193×65cm. Height 58cm. The steps are available with either a carpet tread or with a non-slip wipe clean design.

- 091530781** **A** Non-Slip Tread
- 091139666** **B** With Carpet Base

Maximum user weight



1



1



1



DELIVERY

Delivery is approximately 4 weeks. These items are shipped direct. Oversize items will be subject to additional carriage charges. See pages 790 to 792 for details.



INFORMATION

The maximum user weight refers to the steps only. The hand rails are not fully weight bearing and are for support only.

1



homecraft

2



homecraft

2



homecraft

A

1 Homecraft Corner Steps with Weight Bearing Handrails

Excellent quality steps with non-slip treads. These corner steps are in a set of four, 15cm deep one side and three steps 20cm deep on the other side. The handrails are height adjustable from 40 to 90cm and have a max weight bearing load of 140kg (22st) and are longer shaped to aid wheelchair transfers. Wipe clean paintwork to aid infection control.

Dimensions: Overall Length 145cm. Width 120cm. Height 58cm. Weight 70kg.

091518844

Maximum user weight



2 Corner Steps

Excellent quality hardwood steps, which are carpeted for safety and durability. These corner steps are in a set of four, 15cm deep one side and three 20cm deep on the other side. The handrails are height adjustable from 40 to 90cm.

Dimensions: Length 145cm. Width 120cm. Height 58cm.

Weight 40kg.

091139641 **A** With Carpet Tread

091531417 **B** With Non-Slip Tread

Maximum user weight



MADE TO ORDER

This item is made to order and, therefore, is not refundable.



DELIVERY

Delivery is approximately 4 to 6 weeks. These items are shipped direct. Oversize items will be subject to additional carriage charges. See pages 790 to 792 for details.



INFORMATION

The maximum user weight refers to the steps only. The hand rails are not fully weight bearing and are for support only.



1



1 Space Saving Steps

These stairs are made up of 2 sections and can be quickly adjusted so that they slot together, reducing the storage space required. Made from high quality hardwood with the 15cm deep steps covered in durable carpet. Handrails are height adjustable from 40 to 90cm.

Fully assembled: Length 140cm. Width 86cm. Height 60cm.
When compact: Length 87cm. Width 86cm. Height 60cm

- 091136563 **A** With Carpet Tread
- 091531425 **B** Non-Slip Tread

Maximum user weight



2 Paediatric Steps

A scaled down version of the corner steps on page 356, these steps are brightly coloured to brighten any paediatric clinic and aid compliance. On one side there are four steps with a depth of 11.5cm and on the other there are three steps with a depth of 15cm. The handrails adjust from 38cm to 75cm. Length 112cm. Width 94cm. Distance between handrails 450mm.

- 091139658 With Carpet Tread

Maximum user weight

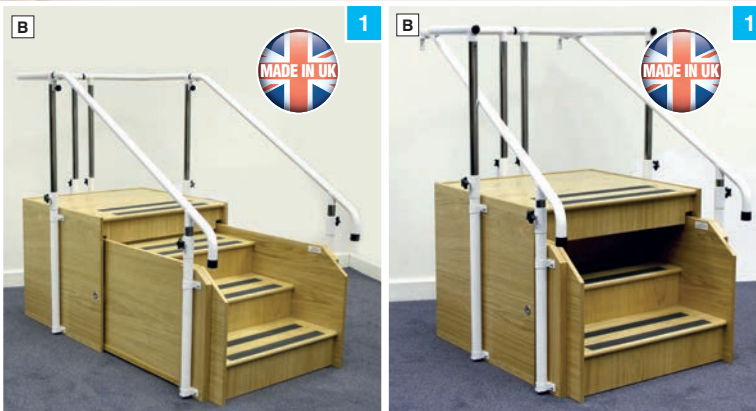

2



DELIVERY

Delivery is approximately 4 weeks. These items are shipped direct. Oversize items will be subject to additional carriage charges. See pages 790 to 792 for details.



MADE TO ORDER

This item is made to order and, therefore, is not refundable.



INFORMATION

The maximum user weight refers to the steps only. The hand rails are not fully weight bearing and are for support only.



1 Nesting Step Stools

This set of wooden step stools is ideal for body mechanics and posture training when standing. Can be used at a desk or during seated mat activities. Non-slip rubber surfaces prevents slipping. Nest for storage. Can be wiped clean. Set of four includes the following sizes:

Height	Width	Depth
20cm	50cm	45cm
15cm	45cm	40cm
10cm	40cm	35cm
5cm	35cm	30cm

091139138

Maximum user weight



2 Ramp and Step Set

Great value for money. This ramp and step set can be used for a whole range of rehabilitation activities including ramp training, posture training and body mechanics. All surfaces are covered with non-slip rubber to provide safety and promote confidence. Can be wiped clean. Ramp platform measures 100x120cm. Ramp incline is 1:6. Three steps include the following sizes:

Height	Width	Depth
5cm	70cm	40cm
10cm	80cm	40cm
15cm	90cm	40cm
20cm	100cm	100cm

091134667

Maximum user weight



DELIVERY

Delivery is approximately 4 weeks. These items are shipped direct. Oversize items will be subject to additional carriage charges. See pages 790 to 792 for details.

1 Height Adjustable Folding Parallel Bars

These parallel bars provide excellent stability and are extremely robust. The bars have a non-slip plastic laminate coating, and the base is a hardwearing powder coated steel and chrome frame, for durability. The bars may be folded flat for easy storage making them ideal for a multi-use therapy room or gymnasium. Height adjustment 69 to 100cm with easy to use locking pins. Height 69 to 100cm. Length 230cm. Width 66cm. Handrail diameter 45mm.

091139476

Maximum user weight



2 Junior - Height Adjustable Folding Parallel Bars

Same design as the parallel bars above, except with a smaller specification to accommodate children. Height 40 to 65cm. Length 186cm. Width 36cm. Handrail diameter 25mm.

091135664

Maximum user weight



3 Width and Height Adjustable Parallel Bars

Both the height and width are adjustable on these parallel bars and they can also be folded down for storage. Can be bolted to the floor. Stable and extremely robust with a non-slip plastic laminate coating. Height is adjustable with easy to use locking pins from 69 to 100cm. Width adjustable from 40 to 61cm. Length 230cm. Handrail diameter 45mm.

091136555

Maximum user weight



1



2



3



SAME DAY DESPATCH

Delivered from stock, orders received before 4pm are despatched the same day. Oversize items will be subject to additional carriage charges. See pages 790 to 792 for details.



1 Westminster Parallel Bars

An extensive range of parallel bars to suit your clinics needs. Available in a variety of lengths, with single or double bars, which can be fixed to wooden or solid floor. A free standing wooden carpet base with sloping ends is also available. Dimensions: Double bar - upper rail height 90cm - lower rail height 90cm. Handrail diameter 45mm.

Single	Length	For Use With
091139526	182cm	182cm Bars
091139534	335cm	335cm Bars
Double	Length	
091139484	182cm	
091139500	487cm	
CarpetBase	Length & Width	
091139609	250x120cm	
091139617	400x120cm	

Maximum user weight



SAME DAY DESPATCH
 Delivered from stock, orders received before 4pm are despatched the same day. Oversize items will be subject to additional carriage charges. See pages 790 to 792 for details.

DELIVERY
 Delivery is approximately 4 weeks. These items are shipped direct. Oversize items will be subject to additional carriage charges. See pages 790 to 792 for details.

MADE TO ORDER
 This item is made to order and, therefore, is not refundable.

INFORMATION
 We recommend installation by a qualified tradesman.

SHOWN WITH CARPET BASE

1 Suspension Frames

A high quality range of suspension frames for walls and ceilings. Manufactured from steel with a white epoxy coating.

091139690 **A** Wall Bar Mounted Frame (69×69cm)

Maximum user weight



2 Wall Bars

Wall bars in polished pine, available in single, double and triple sections to suit your clinic requirements. The units are supplied complete with wall fixing kit and instructions.

091139435 Single Section 270×86cm

091139443 Double Section 270×167cm

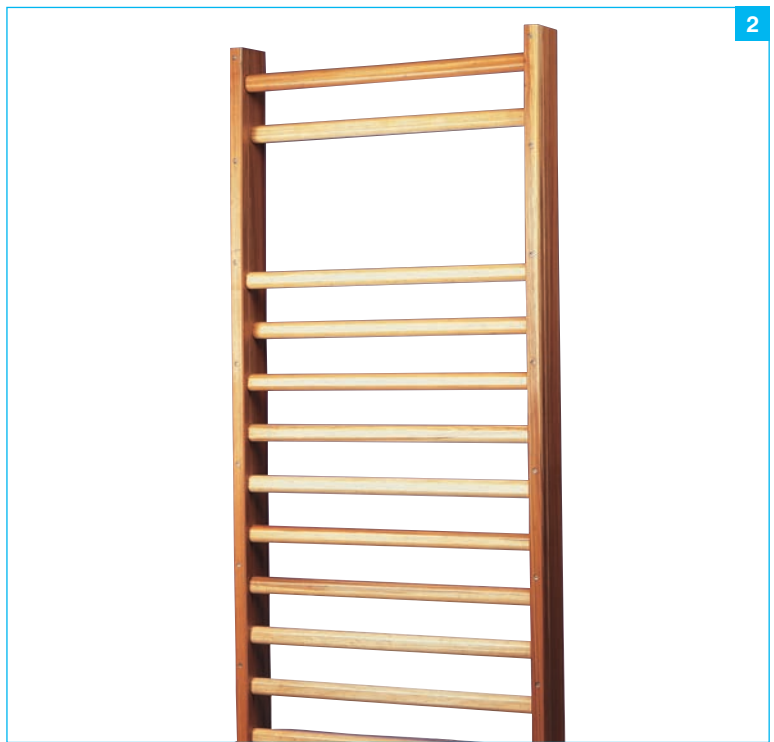

3 Foot Rest with Bag

The foot rest is perfect for the use during domestic work, and assists you in putting the patient's foot where you can best work on it. Height (between 46-92mm) and multiple angles are separately adjustable. The jolt is extra steel reinforced to prevent breaking under weight. This latest model has some further protective construction to give it more stability. Comes with a carry bag (W 690×H 320×D 240mm).

091218288

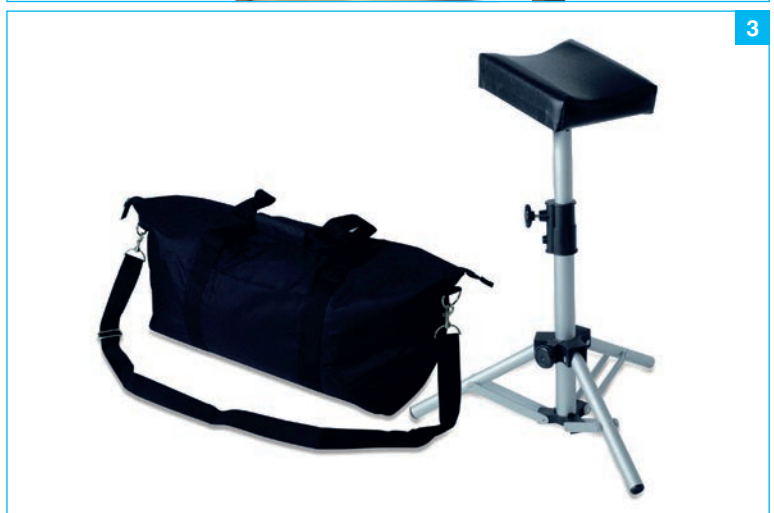

DELIVERY

Delivery is approximately 4 weeks. These items are shipped direct. Oversize items will be subject to additional carriage charges. See pages 790 to 792 for details.



MADE TO ORDER

This item is made to order and, therefore, is not refundable.



1 Rolyan® Reach'N Range Overhead Pulley

Simple to use for re-building muscles and increasing range of motion. Dual overhead pulley offers extra stability and can be used with weights on one handle to counterbalance the strength of the opposite extremity. Weights (not included) can be added as strength improves. Overhead system positions the patient away from the door, allowing more free range-of-motion patterns, such as PNF patterns. Appropriate for home and clinic use.

081297134

2 Rolyan® Reach'N Range Pulley

Easy-to-use pulley system for strengthening weakened shoulders and increasing range of motion. Features the innovative, easily adjusted ROM stop to control range-of-motion patterns. Easy length adjustability to fit patients quickly. Lightweight and compact for travelling convenience. Fits standard and thick doors. Recommended for home use only.

081297167 A With Webbing Strap
081297175 B With Metal Bracket

